

NOTE: This PDF document includes interactive bookmarks, page numbers and tabs for easy navigation.
CLICK HERE for more information on navigating within this PDF document.

**DOCUMENT INCLUDES PRICE INCREASE
EFFECTIVE JULY 1, 2010**

MAGNA DESIGN

by WATSON

2010 Mod Eight Product Price List



GENERAL SERVICES ADMINISTRATION

Federal Acquisition Service

Authorized Federal Supply Schedule Price List

On-line access to contract ordering information, terms and conditions, up-to-date pricing, and the option to create an electronic delivery order are available through GSA Advantage!, a menu-driven database system. The INTERNET address GSA Advantage! is GSAAvantage.gov.

FSC Group 71, Part I, Office Furniture

FSC Class 7110

Contract Number: GS-29F-0109G

Contract Period: 10/01/06 - 09/30/11

For more information on ordering from Federal Supply Schedules click on the FSS Schedules button at fss.gsa.gov.

WATSON FURNITURE GROUP

26246 Twelve Trees Lane NW

Poulsbo, WA 98370

Phone: (360) 394-1300

Fax: (360) 394-1322

Toll Free: (800) 426-1202

Website: www.watsondesking.com

Business Size: Small

SUSTAINABLE BEAUTY. Masterfully Designed, Mindfully Made.

71, Part I, OFFICE FURNITURE

Free Standing Computer Furniture, Workstations, Conference Room and Multi-purpose Tables, Display and Communication Boards.

GENERAL SERVICES ADMINISTRATION - Federal Supply Service - Authorized Federal Supply Schedule - Price List / Catalog

Schedule Title: Office Furniture
FSC Group 71, Part I, FSC Class 7110-1045
Contract No.: GS-29F-0109G
Contract End Date: 12-31-2011

Contractor: Magna Design

26246 Twelve Trees Lane NW
Poulsbo, Washington 98370
Tel: 800.426.1202 Fax: 360.394.1322
Eml: info@magnadesign.com

Business Size: Large

On-line access to Contract ordering information, terms and conditions, up-to-date pricing, and the option to create an electronic delivery is available through *GSA Advantage!™*, a menu-driven database system.

The internet address for *GSA Advantage!™* is: <http://www.gsa.gov>

Effective July 20, 2007, this GSA contract includes our freight and fuel surcharges. For details, see page 3.

1. **Special Item Numbers (SIN)**
 - 711-2 Worksurfaces, workstations, computer furniture and related items.
 - 711-3 Filing and storage cabinets, shelves, mobile carts, dollies, racks and accessories.
 - 711-11 Tables
 - 711-12 Modular connecting tables
 - 711-94 Design and Layout
 - 711-95 Installation

2. **Maximum Order Limitation:**
 - SIN 711-2,3,11,12 \$ 500,000.00
 - SIN 711-94 \$45.00 per hour
 - SIN 711-95 16% of net up to \$3,125 net over \$3,125 net, negotiated per order

3. **Minimum Order Limitation: \$ 100.00 all SIN**

4. **Geographic coverage: All 50 states**

5. **Point of Production:**
Magna Design
26246 Twelve Trees Lane NW
Poulsbo, WA 98370

6. **Discount from List:**
for SIN 711-2, 711-3, 711-11, 711-12, 711-94, 711-95
All shipments are F.O.B. Magna Design plant, Lynnwood, WA. Prices shown are LIST and do NOT include crating, cartoning, storage or inside delivery.

Our standard shipping is 'blanket wrapped'. When using the 'Customer pays freight' discount, the 'common carrier' may require our products to be shipped in wood crates. The 'crating' charge is 8% of the product net price.

Effective July 20, 2007 our freight / fuel surcharge applies to all GSA orders. See page 3 for details.

Based on Magna Design's Price List Books below:

Conference and Meeting,
October 2007 - Purple cover or
August 2006 - Dark Green Cover plus 6%

Use the following discounts:

Customer pays freight:
Discount from List Price to Customer NET is 57.90% and then the charges below are added as needed.

Add 8% of the product total for crating if the shipment is not 'blanket-wrap'

Factory freight program:

Discount from List Price to Customer NET is 52.62% and then the charges below are added as needed.
10% freight surcharge on orders less than \$10,000 List
1% fuel surcharge on orders over List \$10,000 and less than NET \$30,000 to the 'West' region

2% fuel surcharge on orders over List \$10,000 and less than NET \$45,000 to the 'Mid-West' region
3% fuel surcharge on orders over List \$10,000 and less than NET \$60,000 to the 'East' region

Based on Magna Design's Price List Books below:

Modular 8 Components,
October 2007 - Purple cover or
August 2006 - Dark Green Cover plus 6%

~~**Equations,**
October 2007 - Purple cover or
August 2006 - Dark Green Cover plus 6%~~

Series 50,
October 2007 - Purple cover or
August 2006 - Dark Green Cover plus 6%

Use the following discounts:

Customer pays freight:
Discount from List Price to Customer NET is 59.90% and then the charges below are added as needed.

Add 8% of the product total for crating if the shipment is not 'blanket-wrap'

Factory freight program:

Discount from List Price to Customer NET is 54.88% and then the charges below are added as needed.
10% freight surcharge on orders less than \$10,000 List
1% fuel surcharge on orders over List \$10,000 and less than NET \$30,000 to the 'West' region
2% fuel surcharge on orders over List \$10,000 and less than NET \$45,000 to the 'Mid-West' region
3% fuel surcharge on orders over List \$10,000 and less than NET \$60,000 to the 'East' region

7. **Quantity Discounts (based on NET prices):**

SIN 711-2, and SIN 711-3	
\$ 15,000 - \$ 50,000	1.0 %
\$ 50,001 - \$ 100,000	2.0 %
\$ 100,001 - \$ 500,000	3.0 %
SIN 711-11, and SIN 711-12	
\$ 15,000 - \$ 50,000	1.0 %
\$ 50,001 - \$ 100,000	2.0 %
\$ 100,001 - \$ 500,000	4.5 %

8. **Prompt Payment Terms: NET 30 days**

9. **Government Credit Cards: Accepted (no additional discount)**

10. **Foreign items None**

11a. **Time of Delivery 10 - 45 days ARO**

11b. **Expedited Delivery**
MagnaNOW! Product ONLY
Equations Standard components and configurations using current WoodPlus standard finishes.
Per Equations Pricelist, August 2006, pg. 9-49.

Modular 8 WoodPlus components and configurations using WoodPlus edges and WoodPlus current finishes, per Mod 8 Components Price Catalog, August 2006.

Series 50 WoodPlus components and configurations using WoodPlus edges and WoodPlus components per Series 50 Price List, August 2006.

Glass doors not included
Reception stations and Storage Towers NOT included.
Hutches over 84" long NOT included.

WoodPlus Conference Tables using WoodPlus edges and current finishes and finish patterns, as shown on page 3 of the Conference and Meeting Price Catalog August 2006.

12 F.O.B. Point:

Poulsbo, Washington

Freight Claims: Before signing a delivery receipt, make certain that the goods are inspected for possible damage. If there is visual damage, record the extent of the damage on all copies of the Bill of Lading before signing. If there is no visual damage to goods that are cartoned or crated, we strongly suggest that the merchandise be unpacked and inspected immediately. If damages are discovered, save the packaging and contact the carrier immediately for inspection. Claims for damages should be filed with the delivering carrier and payment for the goods may not be withheld pending settlement of the carrier damage claims. Magna Design assumes no liability for freight damage.

Ordering Information

13. Ordering Address:

Magna Design
26246 Twelve Trees Lane NW
Poulsbo, WA 98370
Tel: 800.426.1202
Fax: 360.394.1322

14. Payment Address:

Magna Design
26246 Twelve Trees Lane NW
Poulsbo, WA 98370
Tel: 800.426.1202
Fax: 360.394.1322

15. WARRANTY

Magna Design warrants that its products are free from defects in design, material and workmanship under normal use with proper care and maintenance.

This warranty will remain in effect for the following period of time, commencing with the date of purchase from MAGNA DESIGN, but only so long as the original purchaser continues to own the product:

- WoodPlus² finishes on product purchased January 2002 or later LIFETIME
- Drawer Slides. LIFETIME
- LIFETIME for all products and components, not shown below.
- Magnacare Healthcare furniture TEN (10) years
- Electrical components and functional mechanisms such as keyboard trays FIVE (5) years
- Wood edges. THREE (3) years

During the term of this Warranty, Magna Design will repair or replace without charge any product or part that malfunctions or fails to conform to this Warranty. THIS REMEDY OF REPAIR OR REPLACEMENT IS PURCHASER'S SOLE AND EXCLUSIVE REMEDY WITH REGARD TO ANY PRODUCT DEFECT.

This Warranty does not apply to:
Any Damage caused during shipment
Any product installed or used other than in accordance with MAGNA DESIGN guidelines.
Any product that has been repaired, altered or modified by any person other than MAGNA DESIGN.
Any attachment added to a product
Any fabric or upholstery material
Any part or material provided by Purchaser, or
Any damage caused by misuse, abuse or negligence on the part of Purchaser or any third party.

THERE ARE NO OTHER WARRANTIES, EITHER EXPRESSED OR IMPLIED, INCLUDING ANY WARRANTY OF MERCHANTABILITY OR OF FITNESS FOR A PARTICULAR PURPOSE. UNDER NO CIRCUMSTANCE WILL MAGNA DESIGN BE LIABLE FOR ANY CONSEQUENTIAL OR INCIDENTAL DAMAGES ARISING FROM ANY PRODUCT DEFECT.

This warranty is in effect for products shipped on or after May 1, 1998.

16. Export Packing Charges:
Contact factory for quotation on Export packing charges

17. Credit Card Terms Yes, no additional discounts

18. Rental, Maintenance N/A

19. Installation Terms 16% of net up to \$3,125 net over \$3,125 net, negotiated per order

20. Repair Parts Terms N/A

21. List of Services and Distribution Points N/A

22. Preventive Maintenance N/A

23. Inside Delivery
The actual cost incurred for providing inside delivery services will be negotiated between Magna Design and the customer.

24. Returns, Cancellations & Change Policy

Returned Goods: No product may be returned without 20 days prior written notice and written Returned Goods Authorization (RGA) from Magna Design. Returned goods will be subject to a minimum 15% restocking charge in addition to shipping costs. (See Warranty policy for defective goods).

Cancellations: A 15% restocking charge will be applied on cancellations of standard Products. Cancellations will not be accepted on special or custom products.

Custom or Specials: Returns or cancellations on special or custom products will not be accepted.

Change orders: Order entry will take place upon receipt of a Purchase Order from an authorized Magna Design dealer. Subsequent order changes will be subject to a minimum \$25.00 processing fee. Actual change order charges may be higher depending the status of the job at the time a change is made.

25. Participating Dealers:

Please contact MAGNA DESIGN, INC.,
Customer Service at Tel: 800.426.1202 or
<http://www.magnadesign.com>
for the nearest Participating Dealer in your area.

Product included on contract

Modular 8 Components Pricelist

SIN 711-2 pages	17 - 48	51	53 except cab
	54 - 66	70 except file cab	
	71 - 102	105 - 107	109 - 130
		133 - 153	
SIN 711-3 pages	50	52 - 53 file cab	68 - 69
	70 file cab	104	108

Equations Pricelist

SIN 711-2 pages	9 - 24,	26 - 31	34 - 44
	47 - 66	68 - 72	75
	77 - 91	94	96 - 100
	25 all but EQ-166		
SIN 711-3 pages	25	EQ-166	32 peds
	33	46	67 EQ2-166
	73 peds	74	76
	92 peds	93	95
SIN 711-11 pages	32 tables	73 tables	92 tables

Series 50 Price List

SIN 711-11 page	15
SIN 711-2 pages	7 - 14, 18 - 20, 27
SIN 711-3 pages	16, 17, 21 - 28

Conference and Meeting Price List

SIN 711-11 pages	3, 28 - 68, 70 - 74, 76, 108
SIN 711-12 pages	69, 77 - 89
SIN 711-2 pages	91 - 107, 110 - 123, 125 - 126
SIN 711-3 pages	124

WoodPlus² Conference and Meeting
See Conference and Meeting Price List

THIS PAGE INTENTIONALLY LEFT BLANK.

TABLE OF CONTENTS

INTRODUCTION	02
HOW TO ORDER	04
SHELL DESKS	
Rectangle	06
Bow Front	08
Bullet	08
P-Top	09
Corner	09
Extended Corner	10
Storage Components	13
STORAGE SUPPORTED	
How To	18
Rectangle	19
Bow Front	22
Extended Corner	22
Support Components	23
SECONDARY SURFACES	
Return	32
Bridge	33
Extension	34
OVERHEAD STORAGE	
How To	38
Hutch	39
Quarter Round	47
Transaction Top	47
Wall Mount Storage	49
STORAGE TOWERS	
Lateral File	52
Wardrobe	56
Audio/Video	58
Bookcase	61
Library Shelving	63
ACCESSORIES	
Hutch Accessories	66
Wall Mounted Tackboard	68
Storage Accessories	69
Desk Accessories	71
MATERIALS & SPECIFICATIONS	73
TERMS & CONDITIONS	74
FINISHES	76

INTRODUCTION

Mod Eight: Extraordinary Performance

Substance, durability and style harmonize in the commanding, yet timeless, presence of Mod Eight. A comprehensive private office collection, Mod Eight offers flexible configurations with compelling desk shapes and freestanding modular storage options for smart organization. The refined design of grain-through WoodPlus edges, select hardwood edges, metal pulls and glass-paned doors provide an enduring aesthetic and a lifetime of performance.

Magna Design: Sustainable Beauty

Built upon an American-hewn heritage in the Pacific Northwest, Sustainable Beauty is the true essence of Magna Design and reflects our commitment to the fine craftsmanship of modular casegoods and conferencing solutions.

What begins as a fusion of select hardwood edges with environmentally preferred WoodPlus laminate surfaces, results in an unmistakable feeling of longevity and style to meet the highest standards for executive, managerial and collaborative workspaces. A compelling alternative to traditional veneer casegoods, Sustainable Beauty harnesses the warmth of wood and the superior performance of modern laminate technology to create furniture lines that transcend both classical concerns and contemporary expectations.

Freestanding, easy to modify and specify, Magna Design's comprehensive product solutions meet the demands of the modern workplace - masterfully designed and mindfully made.





HOW TO ORDER

SHELL DESKS	PRODUCT	EDGE	FINISHES
A / B	Modesty Panel Full # Half # None	Wood Plus 3mm Detailed Edge Profile	Surface Edge Base Panels
	P W H	D	
30 36	MOD8RE3038	1012 1180 1395	
30 42	MOD8RE3042	1089 1238 1451	
30 48	MOD8RE3048	1059 1235 1451	
30 54	MOD8RE3054	1113 1280 1495	
30 60	MOD8RE3060	1113 1318 1556	
30 66	MOD8RE3066	1136 1541 1579	
30 72	MOD8RE3072	1157 1362 1600	
30 78	MOD8RE3078	1353 1520 1770	
30 84	MOD8RE3084	1353 1520 1770	
30 90	MOD8RE3090	1619 1786 2036	
30 96	MOD8RE3096	1619 1786 2036	
30 102	MOD8RE3102	1790 1957 2220	
30 108	MOD8RE3108	1900 2068 2331	
30 114	MOD8RE3114	1900 2068 2331	
30 120	MOD8RE3120	1900 2068 2331	
36 36	MOD8RE3636	1107 1274 1489	
36 42	MOD8RE3642	1157 1324 1539	
36 48	MOD8RE3648	1157 1324 1539	
36 54	MOD8RE3654	1202 1369 1584	
36 60	MOD8RE3660	1202 1407 1645	
36 66	MOD8RE3666	1239 1534 1772	
36 72	MOD8RE3672	1239 1534 1772	
36 78	MOD8RE3678	1557 1725 1974	
36 84	MOD8RE3684	1557 1725 1974	
36 90	MOD8RE3690	1854 2022 2271	
36 96	MOD8RE3696	1854 2022 2271	
36 102	MOD8RE3102	2038 2205 2469	
36 108	MOD8RE3108	2038 2205 2469	
36 114	MOD8RE3114	2162 2329 2592	
36 120	MOD8RE3120	2162 2329 2592	

Product Dimensions

Product Code

Product Options

Left/Right, Modesty Panel, Edge Options, etc.

Finish Options

Laminates, Edges, etc.

Product Code Indicators

Boxes available to fill out a complete product code.

Index Tabs

Reference sections throughout the price list.

Upgrade Options and Notes

Reference important upgrades or notes that can effect your order.

SHELL DESKS	PRODUCT	EDGE	FINISHES
A / B	Modesty Panel Full # Half # None	Wood Plus 3mm Detailed Edge Profile	Surface Edge Base Panels
	P W H	D	
30 36	MOD8RE3038	1012 1180 1395	
30 42	MOD8RE3042	1089 1238 1451	
30 48	MOD8RE3048	1059 1235 1451	
30 54	MOD8RE3054	1113 1280 1495	
30 60	MOD8RE3060	1113 1318 1556	
30 66	MOD8RE3066	1136 1541 1579	
30 72	MOD8RE3072	1157 1362 1600	
30 78	MOD8RE3078	1353 1520 1770	
30 84	MOD8RE3084	1353 1520 1770	
30 90	MOD8RE3090	1619 1786 2036	
30 96	MOD8RE3096	1619 1786 2036	
30 102	MOD8RE3102	1790 1957 2220	
30 108	MOD8RE3108	1900 2068 2331	
30 114	MOD8RE3114	1900 2068 2331	
30 120	MOD8RE3120	1900 2068 2331	
36 36	MOD8RE3636	1107 1274 1489	
36 42	MOD8RE3642	1157 1324 1539	
36 48	MOD8RE3648	1157 1324 1539	
36 54	MOD8RE3654	1202 1369 1584	
36 60	MOD8RE3660	1202 1407 1645	
36 66	MOD8RE3666	1239 1534 1772	
36 72	MOD8RE3672	1239 1534 1772	
36 78	MOD8RE3678	1557 1725 1974	
36 84	MOD8RE3684	1557 1725 1974	
36 90	MOD8RE3690	1854 2022 2271	
36 96	MOD8RE3696	1854 2022 2271	
36 102	MOD8RE3102	2038 2205 2469	
36 108	MOD8RE3108	2038 2205 2469	
36 114	MOD8RE3114	2162 2329 2592	
36 120	MOD8RE3120	2162 2329 2592	

EXAMPLES

Complete product codes are pieced together in a similar fashion throughout each section. Please note that while working from left to right across the page, additional option codes or upgrades are listed on the lower portion of each page, and finish codes are found on page 76.

Shell Desk (Rectangle)

Product Code MOD8SRE2272 N P S CU CU CU
 Modesty Panel
 Edge Material
 Edge Profile
 Surface Laminate
 Edge Finish
 Base Laminate

SHELL DESKS



Rectangle



Bow Front



Bullet

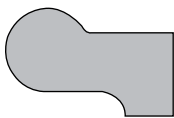
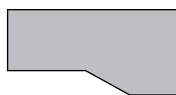

P Top

Corner
AngledCorner
RadiusExtended
Corner BulletExtended
Corner P TopExtended
Corner AngledExtended
Corner Radius

SHELL DESKS	
Rectangle	06
Bow Front	08
Bullet	08
P-Top	09
Corner	09
Extended Corner	10
Storage Components	13

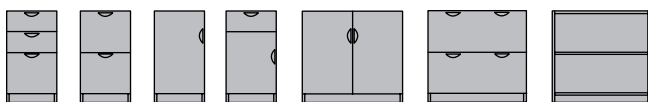

Storage Components

SHELL DESKS

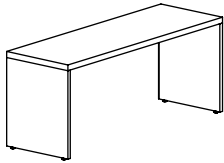

RECTANGLE

A / B

A / B	PRODUCT	Modesty Panel Full = F Half = H No = N	EDGE			Edge Profile See Below	FINISHES		
			Wood Plus P	3mm W	Detailed D		Surface	Edge	Base Panels
			\$	\$	\$				
22 36	MOD8SRE2236	<input type="checkbox"/>	858	1025	1240	<input type="checkbox"/>	<input type="checkbox"/>	<input type="checkbox"/>	<input type="checkbox"/>
22 42	MOD8SRE2242	<input type="checkbox"/>	879	1047	1262	<input type="checkbox"/>	<input type="checkbox"/>	<input type="checkbox"/>	<input type="checkbox"/>
22 48	MOD8SRE2248	<input type="checkbox"/>	879	1047	1262	<input type="checkbox"/>	<input type="checkbox"/>	<input type="checkbox"/>	<input type="checkbox"/>
22 54	MOD8SRE2254	<input type="checkbox"/>	923	1091	1306	<input type="checkbox"/>	<input type="checkbox"/>	<input type="checkbox"/>	<input type="checkbox"/>
22 60	MOD8SRE2260	<input type="checkbox"/>	923	1129	1367	<input type="checkbox"/>	<input type="checkbox"/>	<input type="checkbox"/>	<input type="checkbox"/>
22 66	MOD8SRE2266	<input type="checkbox"/>	1019	1225	1463	<input type="checkbox"/>	<input type="checkbox"/>	<input type="checkbox"/>	<input type="checkbox"/>
22 72	MOD8SRE2272	<input type="checkbox"/>	1019	1225	1463	<input type="checkbox"/>	<input type="checkbox"/>	<input type="checkbox"/>	<input type="checkbox"/>
22 78	MOD8SRE2278	<input type="checkbox"/>	1167	1335	1584	<input type="checkbox"/>	<input type="checkbox"/>	<input type="checkbox"/>	<input type="checkbox"/>
22 84	MOD8SRE2284	<input type="checkbox"/>	1167	1335	1584	<input type="checkbox"/>	<input type="checkbox"/>	<input type="checkbox"/>	<input type="checkbox"/>
22 90	MOD8SRE2290	<input type="checkbox"/>	1574	1741	1991	<input type="checkbox"/>	<input type="checkbox"/>	<input type="checkbox"/>	<input type="checkbox"/>
22 96	MOD8SRE2296	<input type="checkbox"/>	1574	1741	1991	<input type="checkbox"/>	<input type="checkbox"/>	<input type="checkbox"/>	<input type="checkbox"/>
22 102	MOD8SRE22102	<input type="checkbox"/>	1733	1900	2164	<input type="checkbox"/>	<input type="checkbox"/>	<input type="checkbox"/>	<input type="checkbox"/>
22 108	MOD8SRE22108	<input type="checkbox"/>	1733	1900	2164	<input type="checkbox"/>	<input type="checkbox"/>	<input type="checkbox"/>	<input type="checkbox"/>
22 114	MOD8SRE22114	<input type="checkbox"/>	1845	2013	2276	<input type="checkbox"/>	<input type="checkbox"/>	<input type="checkbox"/>	<input type="checkbox"/>
22 120	MOD8SRE22120	<input type="checkbox"/>	1845	2013	2276	<input type="checkbox"/>	<input type="checkbox"/>	<input type="checkbox"/>	<input type="checkbox"/>
24 36	MOD8SRE2436	<input type="checkbox"/>	858	1025	1240	<input type="checkbox"/>	<input type="checkbox"/>	<input type="checkbox"/>	<input type="checkbox"/>
24 42	MOD8SRE2442	<input type="checkbox"/>	879	1047	1262	<input type="checkbox"/>	<input type="checkbox"/>	<input type="checkbox"/>	<input type="checkbox"/>
24 48	MOD8SRE2448	<input type="checkbox"/>	879	1047	1262	<input type="checkbox"/>	<input type="checkbox"/>	<input type="checkbox"/>	<input type="checkbox"/>
24 54	MOD8SRE2454	<input type="checkbox"/>	923	1091	1306	<input type="checkbox"/>	<input type="checkbox"/>	<input type="checkbox"/>	<input type="checkbox"/>
24 60	MOD8SRE2460	<input type="checkbox"/>	923	1129	1367	<input type="checkbox"/>	<input type="checkbox"/>	<input type="checkbox"/>	<input type="checkbox"/>
24 66	MOD8SRE2466	<input type="checkbox"/>	1019	1225	1463	<input type="checkbox"/>	<input type="checkbox"/>	<input type="checkbox"/>	<input type="checkbox"/>
24 72	MOD8SRE2472	<input type="checkbox"/>	1019	1225	1463	<input type="checkbox"/>	<input type="checkbox"/>	<input type="checkbox"/>	<input type="checkbox"/>
24 78	MOD8SRE2478	<input type="checkbox"/>	1167	1335	1584	<input type="checkbox"/>	<input type="checkbox"/>	<input type="checkbox"/>	<input type="checkbox"/>
24 84	MOD8SRE2484	<input type="checkbox"/>	1167	1335	1584	<input type="checkbox"/>	<input type="checkbox"/>	<input type="checkbox"/>	<input type="checkbox"/>
24 90	MOD8SRE2490	<input type="checkbox"/>	1574	1741	1991	<input type="checkbox"/>	<input type="checkbox"/>	<input type="checkbox"/>	<input type="checkbox"/>
24 96	MOD8SRE2496	<input type="checkbox"/>	1574	1741	1991	<input type="checkbox"/>	<input type="checkbox"/>	<input type="checkbox"/>	<input type="checkbox"/>
24 102	MOD8SRE24102	<input type="checkbox"/>	1733	1900	2164	<input type="checkbox"/>	<input type="checkbox"/>	<input type="checkbox"/>	<input type="checkbox"/>
24 108	MOD8SRE24108	<input type="checkbox"/>	1733	1900	2164	<input type="checkbox"/>	<input type="checkbox"/>	<input type="checkbox"/>	<input type="checkbox"/>
24 114	MOD8SRE24114	<input type="checkbox"/>	1845	2013	2276	<input type="checkbox"/>	<input type="checkbox"/>	<input type="checkbox"/>	<input type="checkbox"/>
24 120	MOD8SRE24120	<input type="checkbox"/>	1845	2013	2276	<input type="checkbox"/>	<input type="checkbox"/>	<input type="checkbox"/>	<input type="checkbox"/>

RESOURCES

SHELL STORAGE	13
SECONDARY SURFACES	31
OVERHEAD STORAGE	37
STORAGE TOWERS	51
ACCESSORIES	65
FINISHES	76

Shell Desks larger than 72 inches wide may require additional support. Contact Customer Service for more information.

Modesty Panel finish matches Base Panel finish.

OPTIONS

Grain Direction

Surface grain direction runs the length of the work-surface.

Modesty Panel finish matches base laminate specified and ships standard with horizontal grain direction.

Optional Edge Inlay

A chrome or black edge inlay is available with Detailed edge options. Contact customer service for ordering information.

Grommets

To add factory installed grommets place a "G" after the edge profile code above and add \$56 list for each desk.

Desk Details

Dimension information, optional grommet locations, and modesty panel placement are shown below.

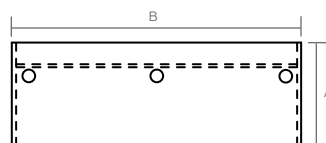

EDGES

Edge Profile	Edge Code
--------------	-----------

WoodPlus & 3mm

	Smooth	S
	Reeded	R
	NeoClassic	E

Detailed

	Radius	D
	Beveled	B
	Transitional	T
	Reeded	R
	Classic	C

For a closer look at edge styles, visit our website.

SHELL DESKS

A / B		PRODUCT	EDGE					FINISHES		
			Modesty Panel Full = F Half = H No = N	Wood Plus P	3mm W	Detailed D	Edge Profile See Below	Surface	Edge	Base Panels
			\$	\$	\$					
30	36	MOD8SRE3036	<input type="checkbox"/>	1012	1180	1395	<input type="checkbox"/>	<input type="checkbox"/>	<input type="checkbox"/>	<input type="checkbox"/>
30	42	MOD8SRE3042	<input type="checkbox"/>	1069	1236	1451	<input type="checkbox"/>	<input type="checkbox"/>	<input type="checkbox"/>	<input type="checkbox"/>
30	48	MOD8SRE3048	<input type="checkbox"/>	1069	1236	1451	<input type="checkbox"/>	<input type="checkbox"/>	<input type="checkbox"/>	<input type="checkbox"/>
30	54	MOD8SRE3054	<input type="checkbox"/>	1113	1280	1495	<input type="checkbox"/>	<input type="checkbox"/>	<input type="checkbox"/>	<input type="checkbox"/>
30	60	MOD8SRE3060	<input type="checkbox"/>	1113	1318	1556	<input type="checkbox"/>	<input type="checkbox"/>	<input type="checkbox"/>	<input type="checkbox"/>
30	66	MOD8SRE3066	<input type="checkbox"/>	1136	1341	1579	<input type="checkbox"/>	<input type="checkbox"/>	<input type="checkbox"/>	<input type="checkbox"/>
30	72	MOD8SRE3072	<input type="checkbox"/>	1157	1362	1600	<input type="checkbox"/>	<input type="checkbox"/>	<input type="checkbox"/>	<input type="checkbox"/>
30	78	MOD8SRE3078	<input type="checkbox"/>	1353	1520	1770	<input type="checkbox"/>	<input type="checkbox"/>	<input type="checkbox"/>	<input type="checkbox"/>
30	84	MOD8SRE3084	<input type="checkbox"/>	1353	1520	1770	<input type="checkbox"/>	<input type="checkbox"/>	<input type="checkbox"/>	<input type="checkbox"/>
30	90	MOD8SRE3090	<input type="checkbox"/>	1619	1786	2036	<input type="checkbox"/>	<input type="checkbox"/>	<input type="checkbox"/>	<input type="checkbox"/>
30	96	MOD8SRE3096	<input type="checkbox"/>	1619	1786	2036	<input type="checkbox"/>	<input type="checkbox"/>	<input type="checkbox"/>	<input type="checkbox"/>
30	102	MOD8SRE30102	<input type="checkbox"/>	1790	1957	2220	<input type="checkbox"/>	<input type="checkbox"/>	<input type="checkbox"/>	<input type="checkbox"/>
30	108	MOD8SRE30108	<input type="checkbox"/>	1790	1957	2220	<input type="checkbox"/>	<input type="checkbox"/>	<input type="checkbox"/>	<input type="checkbox"/>
30	114	MOD8SRE30114	<input type="checkbox"/>	1900	2068	2331	<input type="checkbox"/>	<input type="checkbox"/>	<input type="checkbox"/>	<input type="checkbox"/>
30	120	MOD8SRE30120	<input type="checkbox"/>	1900	2068	2331	<input type="checkbox"/>	<input type="checkbox"/>	<input type="checkbox"/>	<input type="checkbox"/>
36	36	MOD8SRE3636	<input type="checkbox"/>	1107	1274	1489	<input type="checkbox"/>	<input type="checkbox"/>	<input type="checkbox"/>	<input type="checkbox"/>
36	42	MOD8SRE3642	<input type="checkbox"/>	1157	1324	1539	<input type="checkbox"/>	<input type="checkbox"/>	<input type="checkbox"/>	<input type="checkbox"/>
36	48	MOD8SRE3648	<input type="checkbox"/>	1157	1324	1539	<input type="checkbox"/>	<input type="checkbox"/>	<input type="checkbox"/>	<input type="checkbox"/>
36	54	MOD8SRE3654	<input type="checkbox"/>	1202	1369	1584	<input type="checkbox"/>	<input type="checkbox"/>	<input type="checkbox"/>	<input type="checkbox"/>
36	60	MOD8SRE3660	<input type="checkbox"/>	1202	1407	1645	<input type="checkbox"/>	<input type="checkbox"/>	<input type="checkbox"/>	<input type="checkbox"/>
36	66	MOD8SRE3666	<input type="checkbox"/>	1329	1534	1772	<input type="checkbox"/>	<input type="checkbox"/>	<input type="checkbox"/>	<input type="checkbox"/>
36	72	MOD8SRE3672	<input type="checkbox"/>	1329	1534	1772	<input type="checkbox"/>	<input type="checkbox"/>	<input type="checkbox"/>	<input type="checkbox"/>
36	78	MOD8SRE3678	<input type="checkbox"/>	1557	1725	1974	<input type="checkbox"/>	<input type="checkbox"/>	<input type="checkbox"/>	<input type="checkbox"/>
36	84	MOD8SRE3684	<input type="checkbox"/>	1557	1725	1974	<input type="checkbox"/>	<input type="checkbox"/>	<input type="checkbox"/>	<input type="checkbox"/>
36	90	MOD8SRE3690	<input type="checkbox"/>	1854	2022	2271	<input type="checkbox"/>	<input type="checkbox"/>	<input type="checkbox"/>	<input type="checkbox"/>
36	96	MOD8SRE3696	<input type="checkbox"/>	1854	2022	2271	<input type="checkbox"/>	<input type="checkbox"/>	<input type="checkbox"/>	<input type="checkbox"/>
36	102	MOD8SRE36102	<input type="checkbox"/>	2038	2205	2469	<input type="checkbox"/>	<input type="checkbox"/>	<input type="checkbox"/>	<input type="checkbox"/>
36	108	MOD8SRE36108	<input type="checkbox"/>	2038	2205	2469	<input type="checkbox"/>	<input type="checkbox"/>	<input type="checkbox"/>	<input type="checkbox"/>
36	114	MOD8SRE36114	<input type="checkbox"/>	2162	2329	2592	<input type="checkbox"/>	<input type="checkbox"/>	<input type="checkbox"/>	<input type="checkbox"/>
36	120	MOD8SRE36120	<input type="checkbox"/>	2162	2329	2592	<input type="checkbox"/>	<input type="checkbox"/>	<input type="checkbox"/>	<input type="checkbox"/>

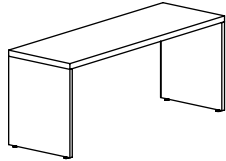

RECTANGLE

RESOURCES

SHELL STORAGE	13
SECONDARY SURFACES	31
OVERHEAD STORAGE	37
STORAGE TOWERS	51
ACCESSORIES	65
FINISHES	76

Shell Desks larger than 72 inches wide may require additional support. Contact Customer Service for more information.

Modesty Panel finish matches Base Panel finish.

OPTIONS

Grain Direction

Surface grain direction runs the length of the work-surface.

Modesty Panel finish matches base laminate specified and ships standard with horizontal grain direction.

Optional Edge Inlay

A chrome or black edge inlay is available with Detailed edge options. Contact customer service for ordering information.

Grommets

To add factory installed grommets place a "G" after the edge profile code above and add \$56 list for each desk.

Desk Details

Dimension information, optional grommet locations, and modesty panel placement are shown below.

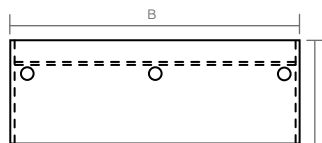

EDGES

Edge Profile		Edge Code
WoodPlus & 3mm		
	Smooth	S
	Reeded	R
	NeoClassic	E
Detailed		
	Radius	D
	Beveled	B
	Transitional	T
	Reeded	R
	Classic	C

For a closer look at edge styles, visit our website.

SHELL DESKS

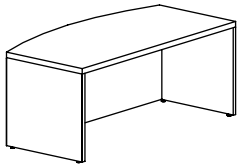

BOW FRONT

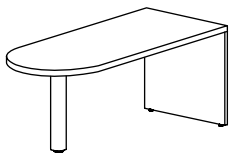

BULLET

Single Column

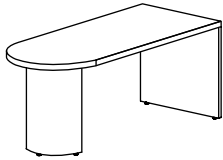

BULLET

Half Cylinder
Left Hand Shown

A / B

PRODUCT		EDGE						FINISHES					
A	B	Product	Left = L	Modesty	Wood	3mm	Detailed	Edge	Surface	Edge	Base	Base	Half
			Right = R	Panel	Plus			Profile					
					P	W	D	See Below					
					\$	\$	\$						
36	72	MOD8SBF3672	-	<input type="checkbox"/>	1547	1753	1991	<input type="checkbox"/>	<input type="checkbox"/>	<input type="checkbox"/>	<input type="checkbox"/>	-	-
36	78	MOD8SBF3678	-	<input type="checkbox"/>	1776	1981	2219	<input type="checkbox"/>	<input type="checkbox"/>	<input type="checkbox"/>	<input type="checkbox"/>	-	-
36	84	MOD8SBF3684	-	<input type="checkbox"/>	1776	1981	2219	<input type="checkbox"/>	<input type="checkbox"/>	<input type="checkbox"/>	<input type="checkbox"/>	-	-
42	72	MOD8SBF4272	-	<input type="checkbox"/>	1667	1972	2260	<input type="checkbox"/>	<input type="checkbox"/>	<input type="checkbox"/>	<input type="checkbox"/>	-	-
42	78	MOD8SBF4278	-	<input type="checkbox"/>	1905	2213	2551	<input type="checkbox"/>	<input type="checkbox"/>	<input type="checkbox"/>	<input type="checkbox"/>	-	-
42	84	MOD8SBF4284	-	<input type="checkbox"/>	1905	2213	2551	<input type="checkbox"/>	<input type="checkbox"/>	<input type="checkbox"/>	<input type="checkbox"/>	-	-
30	60	MOD8SBU3060S	N	N	1614	2036	2272	<input type="checkbox"/>	<input type="checkbox"/>	<input type="checkbox"/>	<input type="checkbox"/>	<input type="checkbox"/>	-
30	66	MOD8SBU3066S	N	N	1712	2134	2371	<input type="checkbox"/>	<input type="checkbox"/>	<input type="checkbox"/>	<input type="checkbox"/>	<input type="checkbox"/>	-
30	72	MOD8SBU3072S	N	N	1757	2179	2416	<input type="checkbox"/>	<input type="checkbox"/>	<input type="checkbox"/>	<input type="checkbox"/>	<input type="checkbox"/>	-
36	60	MOD8SBU3660S	N	N	1803	2225	2462	<input type="checkbox"/>	<input type="checkbox"/>	<input type="checkbox"/>	<input type="checkbox"/>	<input type="checkbox"/>	-
36	66	MOD8SBU3666S	N	N	1859	2280	2517	<input type="checkbox"/>	<input type="checkbox"/>	<input type="checkbox"/>	<input type="checkbox"/>	<input type="checkbox"/>	-
36	72	MOD8SBU3672S	N	N	1907	2329	2566	<input type="checkbox"/>	<input type="checkbox"/>	<input type="checkbox"/>	<input type="checkbox"/>	<input type="checkbox"/>	-
30	60	MOD8SBU3060H	<input type="checkbox"/>	<input type="checkbox"/>	1981	2354	2591	<input type="checkbox"/>	<input type="checkbox"/>	<input type="checkbox"/>	<input type="checkbox"/>	-	<input type="checkbox"/>
30	66	MOD8SBU3066H	<input type="checkbox"/>	<input type="checkbox"/>	2098	2459	2696	<input type="checkbox"/>	<input type="checkbox"/>	<input type="checkbox"/>	<input type="checkbox"/>	-	<input type="checkbox"/>
30	72	MOD8SBU3072H	<input type="checkbox"/>	<input type="checkbox"/>	2131	2505	2741	<input type="checkbox"/>	<input type="checkbox"/>	<input type="checkbox"/>	<input type="checkbox"/>	-	<input type="checkbox"/>
30	78	MOD8SBU3078H	<input type="checkbox"/>	F	2515	2888	3136	<input type="checkbox"/>	<input type="checkbox"/>	<input type="checkbox"/>	<input type="checkbox"/>	-	<input type="checkbox"/>
30	84	MOD8SBU3084H	<input type="checkbox"/>	F	2515	2888	3136	<input type="checkbox"/>	<input type="checkbox"/>	<input type="checkbox"/>	<input type="checkbox"/>	-	<input type="checkbox"/>
36	60	MOD8SBU3660H	<input type="checkbox"/>	<input type="checkbox"/>	2219	2592	2829	<input type="checkbox"/>	<input type="checkbox"/>	<input type="checkbox"/>	<input type="checkbox"/>	-	<input type="checkbox"/>
36	66	MOD8SBU3666H	<input type="checkbox"/>	<input type="checkbox"/>	2277	2650	2887	<input type="checkbox"/>	<input type="checkbox"/>	<input type="checkbox"/>	<input type="checkbox"/>	-	<input type="checkbox"/>
36	72	MOD8SBU3672H	<input type="checkbox"/>	<input type="checkbox"/>	2329	2702	2939	<input type="checkbox"/>	<input type="checkbox"/>	<input type="checkbox"/>	<input type="checkbox"/>	-	<input type="checkbox"/>
36	78	MOD8SBU3678H	<input type="checkbox"/>	F	2670	3043	3291	<input type="checkbox"/>	<input type="checkbox"/>	<input type="checkbox"/>	<input type="checkbox"/>	-	<input type="checkbox"/>
36	84	MOD8SBU3684H	<input type="checkbox"/>	F	2670	3043	3291	<input type="checkbox"/>	<input type="checkbox"/>	<input type="checkbox"/>	<input type="checkbox"/>	-	<input type="checkbox"/>

RESOURCES

SHELL STORAGE	13
SECONDARY SURFACES	31
OVERHEAD STORAGE	37
STORAGE TOWERS	51
ACCESSORIES	65
FINISHES	76

Shell Desks larger than 72 inches wide may require additional support. Contact Customer Service for more information.

Bullet Half Cylinder base is 18 inches wide.

78 and 84 inch Bullets with a Half Cylinder base require a Full Modesty option.

Modesty Panel finish matches Base Panel finish.

OPTIONS

Grain Direction

Surface grain direction runs the length of the work-surface.

Modesty Panel finish matches base laminate specified and ships standard with horizontal grain direction.

Optional Edge Inlay

A chrome or black edge inlay is available with Detailed edge options. Contact customer service for ordering information.

Grommets

To add factory installed grommets place a "G" after the edge profile code above and add \$56 list for each desk.

Desk Details

Dimension information, optional grommet locations, and modesty panel placement are shown below.

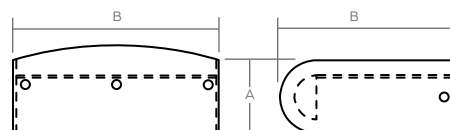

EDGES

Edge Profile

Edge Code

WoodPlus & 3mm



Smooth

S



Reeded

R



NeoClassic

E

Detailed



Radius

D



Beveled

B



Transitional

T



Reeded

R



Classic

C

For a closer look at edge styles, visit our website.

SHELL DESKS

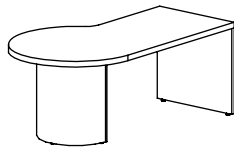
**P-TOP**

Half Cylinder

Right Hand Shown

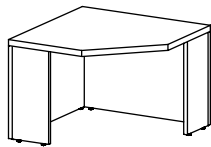
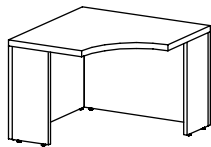
**CORNER ANGLED****CORNER RADIUS****A / B**42 72
42 78
42 84
42 90
42 96MOD8SPT4272H
MOD8SPT4278H
MOD8SPT4284H
MOD8SPT4290H
MOD8SPT4296HLeft = **L**
Right = **R**Modesty
PanelFull = **F**
Half = **H**Wood
Plus

3mm

Detailed

Edge
Profile

Surface

Edge

Base
PanelsHalf
Cylinder**P****W****D**See
Below

\$

\$

\$

42 24
48 30MOD8SCA4224
MOD8SCA4830- -
- -1494
15791762
18472041
2127

-
-42 24
48 30MOD8SCR4224
MOD8SCR4830- -
- -1828
19282096
21962375
2476

-
-

RESOURCES

SHELL STORAGE	13
SECONDARY SURFACES	31
OVERHEAD STORAGE	37
STORAGE TOWERS	51
ACCESSORIES	65
FINISHES	76

Shell Desks larger than 72 inches wide may require additional support. Contact Customer Service for more information.

90 and 96 inch P-Tops with a Half Cylinder base require a modesty option.

OPTIONS

Grain Direction

P-Top surface grain direction runs the length of the worksurface.

Corner surface grain direction runs side-to-side.

Modesty Panel finish matches base laminate specified and ships standard with horizontal grain direction.

Optional Edge Inlay

A chrome or black edge inlay is available with Detailed edge options. Contact customer service for ordering information.

Grommets

To add factory installed grommets place a "G" after the edge profile code above and add \$56 list for each desk.

Desk Details

Dimension information, optional grommet locations, and modesty panel placement are shown below.

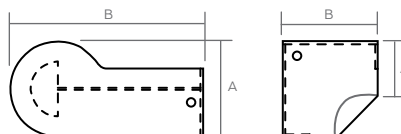

EDGES

Edge Profile		Edge Code
WoodPlus & 3mm		
	Smooth	S
	Reeded	R
	NeoClassic	E
Detailed		
	Radius	D
	Beveled	B
	Transitional	T
	Reeded	R
	Classic	C

For a closer look at edge styles, visit our website.

SHELL DESKS

A / B		PRODUCT			EDGE			FINISHES				
		Depth D	Left = L Right = R	Modesty Panel	Wood Plus	3mm	Detailed	Edge Profile	Surface	Edge	Base Panels	Half Cylinder
		24 or 30		Full = F Half = H No = N	P	W	D	See Below				
					\$	\$	\$					
42	72		<input type="checkbox"/>	<input type="checkbox"/>	2790	3163	3400	<input type="checkbox"/>	<input type="checkbox"/>	<input type="checkbox"/>	<input type="checkbox"/>	<input type="checkbox"/>
42	78		<input type="checkbox"/>	<input type="checkbox"/>	2968	3341	3589	<input type="checkbox"/>	<input type="checkbox"/>	<input type="checkbox"/>	<input type="checkbox"/>	<input type="checkbox"/>
54	72	24	<input type="checkbox"/>	<input type="checkbox"/>	3327	3777	4118	<input type="checkbox"/>	<input type="checkbox"/>	<input type="checkbox"/>	<input type="checkbox"/>	<input type="checkbox"/>
54	78		<input type="checkbox"/>	<input type="checkbox"/>	3528	3978	4350	<input type="checkbox"/>	<input type="checkbox"/>	<input type="checkbox"/>	<input type="checkbox"/>	<input type="checkbox"/>
54	84		<input type="checkbox"/>	<input type="checkbox"/>	3528	3978	4350	<input type="checkbox"/>	<input type="checkbox"/>	<input type="checkbox"/>	<input type="checkbox"/>	<input type="checkbox"/>

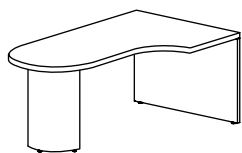
**EXTENDED CORNER, BULLET**

Half Cylinder Base

Right Hand Shown

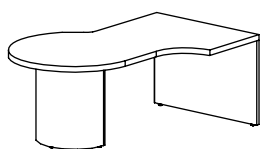
**EXTENDED CORNER, P-TOP**

Half Cylinder Base

Right Hand Shown

RESOURCES

SHELL STORAGE	13
SECONDARY SURFACES	31
OVERHEAD STORAGE	37
STORAGE TOWERS	51
ACCESSORIES	65
FINISHES	76

Desks larger than 72 inches wide may require additional support. Contact Customer Service for information.

Modesty Panel finish matches Base Panel finish.

Dimensions

A = Depth C = Extension Depth
B = Width D = Docking Side

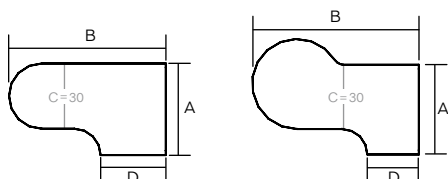

OPTIONS

Grain Direction

Surface grain direction runs the length of the work-surface.

Modesty Panel finish matches base laminate specified and ships standard with horizontal grain direction.

Optional Edge Inlay

A chrome or black edge inlay is available with Detailed edge options. Contact customer service for ordering information.

Grommets

To add factory installed grommets place a "G" after the edge profile code above and add \$56 list for each desk.

Desk Details

Optional grommet locations and modesty panel placement are shown below.

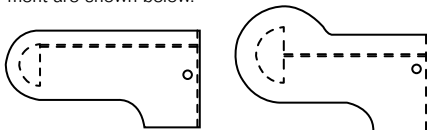

EDGES

Edge Profile**Edge Code****WoodPlus & 3mm**

Smooth

S

Reeded

R

NeoClassic

E**Detailed**

Radius

D

Beveled

B

Transitional

T

Reeded

R

Classic

C

For a closer look at edge styles, visit our website.

SHELL DESKS

PRODUCT

EDGE

FINISHES

A / B

Depth
C
24
or
30Depth
D
24
or
30Left = **L**
Right = **R**Modesty
Panel
Full = **F**
Half = **H**
No = **N**Wood
Plus
P3mm
WDetailed
DEdge
Profile
See
Below

Surface

Edge

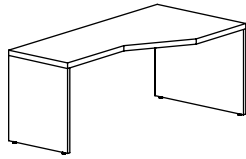
Base
Panels**EXTENDED CORNER, ANGLED**

Right Hand Shown

36	72	MOD8SAC3672	<input type="checkbox"/>	<input type="checkbox"/>	<input type="checkbox"/>	<input type="checkbox"/>	2023	2328	2615	<input type="checkbox"/>	<input type="checkbox"/>	<input type="checkbox"/>	<input type="checkbox"/>
36	78	MOD8SAC3678	<input type="checkbox"/>	<input type="checkbox"/>	<input type="checkbox"/>	<input type="checkbox"/>	2238	2546	2883	<input type="checkbox"/>	<input type="checkbox"/>	<input type="checkbox"/>	<input type="checkbox"/>
36	84	MOD8SAC3684	<input type="checkbox"/>	<input type="checkbox"/>	<input type="checkbox"/>	<input type="checkbox"/>	2238	2546	2883	<input type="checkbox"/>	<input type="checkbox"/>	<input type="checkbox"/>	<input type="checkbox"/>
36	90	MOD8SAC3690	<input type="checkbox"/>	<input type="checkbox"/>	<input type="checkbox"/>	<input type="checkbox"/>	2633	2941	3278	<input type="checkbox"/>	<input type="checkbox"/>	<input type="checkbox"/>	<input type="checkbox"/>
36	96	MOD8SAC3696	<input type="checkbox"/>	<input type="checkbox"/>	<input type="checkbox"/>	<input type="checkbox"/>	2633	2941	3278	<input type="checkbox"/>	<input type="checkbox"/>	<input type="checkbox"/>	<input type="checkbox"/>
36	102	MOD8SAC36102	<input type="checkbox"/>	<input type="checkbox"/>	<input type="checkbox"/>	<input type="checkbox"/>	2830	3143	3516	<input type="checkbox"/>	<input type="checkbox"/>	<input type="checkbox"/>	<input type="checkbox"/>
36	108	MOD8SAC36108	<input type="checkbox"/>	<input type="checkbox"/>	<input type="checkbox"/>	<input type="checkbox"/>	2830	3143	3516	<input type="checkbox"/>	<input type="checkbox"/>	<input type="checkbox"/>	<input type="checkbox"/>
36	114	MOD8SAC36114	<input type="checkbox"/>	<input type="checkbox"/>	<input type="checkbox"/>	<input type="checkbox"/>	2965	3278	3651	<input type="checkbox"/>	<input type="checkbox"/>	<input type="checkbox"/>	<input type="checkbox"/>
36	120	MOD8SAC36120	<input type="checkbox"/>	<input type="checkbox"/>	<input type="checkbox"/>	<input type="checkbox"/>	2965	3278	3651	<input type="checkbox"/>	<input type="checkbox"/>	<input type="checkbox"/>	<input type="checkbox"/>
42	72	MOD8SAC4272	<input type="checkbox"/>	<input type="checkbox"/>	<input type="checkbox"/>	<input type="checkbox"/>	2194	2499	2786	<input type="checkbox"/>	<input type="checkbox"/>	<input type="checkbox"/>	<input type="checkbox"/>
42	78	MOD8SAC4278	<input type="checkbox"/>	<input type="checkbox"/>	<input type="checkbox"/>	<input type="checkbox"/>	2419	2727	3065	<input type="checkbox"/>	<input type="checkbox"/>	<input type="checkbox"/>	<input type="checkbox"/>
42	84	MOD8SAC4284	<input type="checkbox"/>	<input type="checkbox"/>	<input type="checkbox"/>	<input type="checkbox"/>	2419	2727	3065	<input type="checkbox"/>	<input type="checkbox"/>	<input type="checkbox"/>	<input type="checkbox"/>
42	90	MOD8SAC4290	<input type="checkbox"/>	<input type="checkbox"/>	<input type="checkbox"/>	<input type="checkbox"/>	2867	3176	3513	<input type="checkbox"/>	<input type="checkbox"/>	<input type="checkbox"/>	<input type="checkbox"/>
42	96	MOD8SAC4296	<input type="checkbox"/>	<input type="checkbox"/>	<input type="checkbox"/>	<input type="checkbox"/>	2867	3176	3513	<input type="checkbox"/>	<input type="checkbox"/>	<input type="checkbox"/>	<input type="checkbox"/>
42	102	MOD8SAC42102	<input type="checkbox"/>	<input type="checkbox"/>	<input type="checkbox"/>	<input type="checkbox"/>	3087	3400	3773	<input type="checkbox"/>	<input type="checkbox"/>	<input type="checkbox"/>	<input type="checkbox"/>
42	108	MOD8SAC42108	<input type="checkbox"/>	<input type="checkbox"/>	<input type="checkbox"/>	<input type="checkbox"/>	3087	3400	3773	<input type="checkbox"/>	<input type="checkbox"/>	<input type="checkbox"/>	<input type="checkbox"/>
42	114	MOD8SAC42114	<input type="checkbox"/>	<input type="checkbox"/>	<input type="checkbox"/>	<input type="checkbox"/>	3233	3546	3919	<input type="checkbox"/>	<input type="checkbox"/>	<input type="checkbox"/>	<input type="checkbox"/>
42	120	MOD8SAC42120	<input type="checkbox"/>	<input type="checkbox"/>	<input type="checkbox"/>	<input type="checkbox"/>	3233	3546	3919	<input type="checkbox"/>	<input type="checkbox"/>	<input type="checkbox"/>	<input type="checkbox"/>

RESOURCES

SHELL STORAGE	13
SECONDARY SURFACES	31
OVERHEAD STORAGE	37
STORAGE TOWERS	51
ACCESSORIES	65
FINISHES	76

Desks larger than 72 inches wide may require additional support. Contact Customer Service for information.

Modesty Panel finish matches Base Panel finish.

42 inch deep Extended Corner with a 24 inch deep extension "C" can only be specified with a 24 inch deep docking side "D".

Dimensions

A = Depth C = Extension Depth
B = Width D = Docking Side

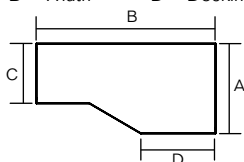

OPTIONS

Grain Direction

Surface grain direction runs the length of the work surface.

Modesty Panel finish matches base laminate specified and ships standard with horizontal grain direction.

Optional Edge Inlay

A chrome or black edge inlay is available with Detailed edge options. Contact customer service for ordering information.

Grommets

To add factory installed grommets place a "G" after the edge profile code above and add \$56 list for each desk.

Desk Details

Optional grommet locations and modesty panel placement are shown below.

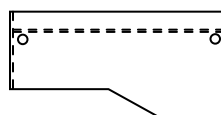

EDGES

Edge Profile		Edge Code
WoodPlus & 3mm		
	Smooth	S
	Reeded	R
	NeoClassic	E
Detailed		
	Radius	D
	Beveled	B
	Transitional	T
	Reeded	R
	Classic	C

For a closer look at edge styles, visit our website.

SHELL DESKS

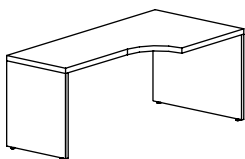
**EXTENDED CORNER, RADIUS**

Right Hand Shown

A / B

36 72
36 78
36 84
36 90
36 96
36 102
36 108
36 114
36 120

42 72
42 78
42 84
42 90
42 96
42 102
42 108
42 114
42 120

PRODUCT		EDGE				FINISHES						
		Depth C	Depth D	Left = L Right = R	Modesty Panel	Wood Plus	3mm	Detailed	Edge Profile	Surface	Edge	Base Panels
A / B		24 or 30	24 or 30		Full = F Half = H No = N	P	W	D	See Below			
						\$	\$	\$				
	MOD8SRC3672	24	<input type="checkbox"/>	<input type="checkbox"/>	<input type="checkbox"/>	2126	2431	2718	<input type="checkbox"/>	<input type="checkbox"/>	<input type="checkbox"/>	<input type="checkbox"/>
	MOD8SRC3678	24	<input type="checkbox"/>	<input type="checkbox"/>	<input type="checkbox"/>	2341	2649	2986	<input type="checkbox"/>	<input type="checkbox"/>	<input type="checkbox"/>	<input type="checkbox"/>
	MOD8SRC3684	24	<input type="checkbox"/>	<input type="checkbox"/>	<input type="checkbox"/>	2341	2649	2986	<input type="checkbox"/>	<input type="checkbox"/>	<input type="checkbox"/>	<input type="checkbox"/>
	MOD8SRC3690	24	<input type="checkbox"/>	<input type="checkbox"/>	<input type="checkbox"/>	2748	3057	3394	<input type="checkbox"/>	<input type="checkbox"/>	<input type="checkbox"/>	<input type="checkbox"/>
	MOD8SRC3696	24	<input type="checkbox"/>	<input type="checkbox"/>	<input type="checkbox"/>	2748	3057	3394	<input type="checkbox"/>	<input type="checkbox"/>	<input type="checkbox"/>	<input type="checkbox"/>
	MOD8SRC36102	24	<input type="checkbox"/>	<input type="checkbox"/>	<input type="checkbox"/>	2948	3261	3634	<input type="checkbox"/>	<input type="checkbox"/>	<input type="checkbox"/>	<input type="checkbox"/>
	MOD8SRC36108	24	<input type="checkbox"/>	<input type="checkbox"/>	<input type="checkbox"/>	2948	3261	3634	<input type="checkbox"/>	<input type="checkbox"/>	<input type="checkbox"/>	<input type="checkbox"/>
	MOD8SRC36114	24	<input type="checkbox"/>	<input type="checkbox"/>	<input type="checkbox"/>	3082	3395	3768	<input type="checkbox"/>	<input type="checkbox"/>	<input type="checkbox"/>	<input type="checkbox"/>
	MOD8SRC36120	24	<input type="checkbox"/>	<input type="checkbox"/>	<input type="checkbox"/>	3082	3395	3768	<input type="checkbox"/>	<input type="checkbox"/>	<input type="checkbox"/>	<input type="checkbox"/>
	MOD8SRC4272	<input type="checkbox"/>	<input type="checkbox"/>	<input type="checkbox"/>	<input type="checkbox"/>	2298	2603	2890	<input type="checkbox"/>	<input type="checkbox"/>	<input type="checkbox"/>	<input type="checkbox"/>
	MOD8SRC4278	<input type="checkbox"/>	<input type="checkbox"/>	<input type="checkbox"/>	<input type="checkbox"/>	2520	2828	3165	<input type="checkbox"/>	<input type="checkbox"/>	<input type="checkbox"/>	<input type="checkbox"/>
	MOD8SRC4284	<input type="checkbox"/>	<input type="checkbox"/>	<input type="checkbox"/>	<input type="checkbox"/>	2520	2828	3165	<input type="checkbox"/>	<input type="checkbox"/>	<input type="checkbox"/>	<input type="checkbox"/>
	MOD8SRC4290	<input type="checkbox"/>	<input type="checkbox"/>	<input type="checkbox"/>	<input type="checkbox"/>	2984	3292	3630	<input type="checkbox"/>	<input type="checkbox"/>	<input type="checkbox"/>	<input type="checkbox"/>
	MOD8SRC4296	<input type="checkbox"/>	<input type="checkbox"/>	<input type="checkbox"/>	<input type="checkbox"/>	2984	3292	3630	<input type="checkbox"/>	<input type="checkbox"/>	<input type="checkbox"/>	<input type="checkbox"/>
	MOD8SRC42102	<input type="checkbox"/>	<input type="checkbox"/>	<input type="checkbox"/>	<input type="checkbox"/>	3206	3519	3892	<input type="checkbox"/>	<input type="checkbox"/>	<input type="checkbox"/>	<input type="checkbox"/>
	MOD8SRC42108	<input type="checkbox"/>	<input type="checkbox"/>	<input type="checkbox"/>	<input type="checkbox"/>	3206	3519	3892	<input type="checkbox"/>	<input type="checkbox"/>	<input type="checkbox"/>	<input type="checkbox"/>
	MOD8SRC42114	<input type="checkbox"/>	<input type="checkbox"/>	<input type="checkbox"/>	<input type="checkbox"/>	3349	3662	4035	<input type="checkbox"/>	<input type="checkbox"/>	<input type="checkbox"/>	<input type="checkbox"/>
	MOD8SRC42120	<input type="checkbox"/>	<input type="checkbox"/>	<input type="checkbox"/>	<input type="checkbox"/>	3349	3662	4035	<input type="checkbox"/>	<input type="checkbox"/>	<input type="checkbox"/>	<input type="checkbox"/>

RESOURCES

SHELL STORAGE	13
SECONDARY SURFACES	31
OVERHEAD STORAGE	37
STORAGE TOWERS	51
ACCESSORIES	65
FINISHES	76

Desks larger than 72 inches wide may require additional support. Contact Customer Service for information.

Modesty Panel finish matches Base Panel finish.

42 inch deep Extended Corner surface with a 24 inch deep extension "C" can only be specified with a 24 inch deep docking side "D".

Dimensions

A = Depth C = Extension Depth
B = Width D = Docking Side

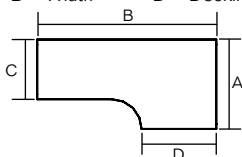

OPTIONS

Grain Direction

Surface grain direction runs the length of the work-surface.

Modesty Panel finish matches base laminate specified and ships standard with horizontal grain direction.

Optional Edge Inlay

A chrome or black edge inlay is available with Detailed edge options. Contact customer service for ordering information.

Grommets

To add factory installed grommets place a "G" after the edge profile code above and add \$56 list for each desk.

Desk Details

Optional grommet locations and modesty panel placement are shown below.

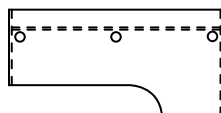

EDGES

Edge Profile**Edge Code****WoodPlus & 3mm**

Smooth

S

Reeded

R

NeoClassic

E**Detailed**

Radius

D

Beveled

B

Transitional

T

Reeded

R

Classic

C

For a closer look at edge styles, visit our website.

SHELL STORAGE

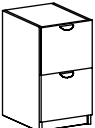
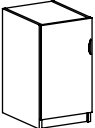
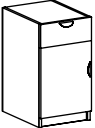
		PRODUCT		OPTIONS		FINISHES	
D / W / H		Left = L Right = R	Price	Lock = L Alike = U See Below	Pull See Below	Case	Face
			\$				
TWO BOX / FILE	20 15 29	MOD8SS2BF201529	993	<input type="checkbox"/>	<input type="checkbox"/>	<input type="checkbox"/>	<input type="checkbox"/>
							
TWO FILE	20 15 29	MOD8SS2F201529	993	<input type="checkbox"/>	<input type="checkbox"/>	<input type="checkbox"/>	<input type="checkbox"/>
							
SINGLE DOOR <i>Left Hand Shown</i>	20 15 29	MOD8SSD201529	941	<input type="checkbox"/>	<input type="checkbox"/>	<input type="checkbox"/>	<input type="checkbox"/>
							
BOX / SINGLE DOOR <i>Left Hand Shown</i>	20 15 29	MOD8SSBD201529	993	<input type="checkbox"/>	<input type="checkbox"/>	<input type="checkbox"/>	<input type="checkbox"/>



RESOURCES

STORAGE ACCESSORIES	69
FINISHES	76

All file drawers are provided with file holders configured for letter front to back and legal side to side filing.

All freestanding components are equipped with threaded stem adjustable glides.

PULLS

Pull Style	Pull Color	Pull Code
	Black Silver	12 13
	Black Silver	30 31
	Touchlatch <i>Door units only</i>	NN

Locks

Randomly keyed locks "L" are standard on all storage units. Storage locks can be specified keyed alike "U" if required. Keyed alike option is field installed.

SHELL STORAGE

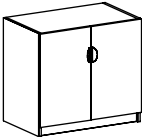
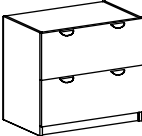
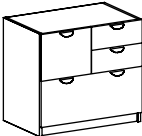
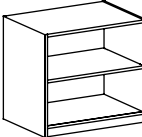
		PRODUCT	OPTIONS		FINISHES		
D / W / H		Left = L Right = R	Price	Lock = L Alike = U See Below	Pull See Below	Case	Face
			\$				
	20 24 29	MOD8SS2D202429	-	953	<input type="checkbox"/>	<input type="checkbox"/> <input type="checkbox"/>	<input type="checkbox"/> <input type="checkbox"/>
	20 30 29	MOD8SS2D203029	-	953	<input type="checkbox"/>	<input type="checkbox"/> <input type="checkbox"/>	<input type="checkbox"/> <input type="checkbox"/>
	20 36 29	MOD8SS2D203629	-	953	<input type="checkbox"/>	<input type="checkbox"/> <input type="checkbox"/>	<input type="checkbox"/> <input type="checkbox"/>
TWO DOOR							
	20 30 29	MOD8SS2L203029	-	1473	<input type="checkbox"/>	<input type="checkbox"/> <input type="checkbox"/>	<input type="checkbox"/> <input type="checkbox"/>
	20 36 29	MOD8SS2L203629	-	1473	<input type="checkbox"/>	<input type="checkbox"/> <input type="checkbox"/>	<input type="checkbox"/> <input type="checkbox"/>
	TWO LATERAL						
	20 30 29	MOD8SS2BFL203029	<input type="checkbox"/>	1704	<input type="checkbox"/>	<input type="checkbox"/> <input type="checkbox"/>	<input type="checkbox"/> <input type="checkbox"/>
	COMBO Left Hand Shown						
	20 15 29	MOD8SSOP201529	-	542	-	-	<input type="checkbox"/> <input type="checkbox"/>
	20 24 29	MOD8SSOP202429	-	542	-	-	<input type="checkbox"/> <input type="checkbox"/>
	20 30 29	MOD8SSOP203029	-	586	-	-	<input type="checkbox"/> <input type="checkbox"/>
	20 36 29	MOD8SSOP203629	-	625	-	-	<input type="checkbox"/> <input type="checkbox"/>
	OPEN						

RESOURCES

PULLS

STORAGE ACCESSORIES

69



FINISHES

76

All file drawers are provided with file holders configured for letter front to back and legal side to side filing.

All freestanding components are equipped with threaded stem adjustable glides.

Two Door and Open storage cabinets do not accommodate two rows of standard binders.

Pull Style	Pull Color	Pull Code
	Black	12
	Silver	13
	Black	30
	Silver	31
Touchlatch Door units only		NN

Locks

Randomly keyed locks "L" are standard on all storage units. Storage locks can be specified keyed alike "U" if required. Keyed alike option is field installed.

MOBILE STORAGE CABINETS

D / W / H	PRODUCT	EDGE			OPTIONS			FINISHES			
		Wood Plus P	3mm W	Edge Profile <i>See Below</i>	Lock= L Alike= U <i>See Below</i>	Pull <i>See Below</i>	Surface	Edge	Case	Face	
20 15 22	MOD8PMBF201522	\$	\$	S	<input type="checkbox"/>	<input type="checkbox"/>	-	-	<input type="checkbox"/>	<input type="checkbox"/>	
24 15 29	MOD8PD2F241529			<input type="checkbox"/>	<input type="checkbox"/>	<input type="checkbox"/>	<input type="checkbox"/>	<input type="checkbox"/>	<input type="checkbox"/>	<input type="checkbox"/>	
24 15 29	MOD8PD2BF241529			<input type="checkbox"/>	<input type="checkbox"/>	<input type="checkbox"/>	<input type="checkbox"/>	<input type="checkbox"/>	<input type="checkbox"/>	<input type="checkbox"/>	
24 15 29	MOD8PD4B241529			<input type="checkbox"/>	<input type="checkbox"/>	<input type="checkbox"/>	<input type="checkbox"/>	<input type="checkbox"/>	<input type="checkbox"/>	<input type="checkbox"/>	



MOBILE BOX FILE

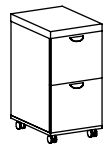

DOCKING TWO FILE

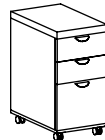

DOCKING TWO BOX FILE





DOCKING FOUR BOX

RESOURCES

STORAGE ACCESSORIES	69
FINISHES	76

Docking Pedestals are worksurface height and include a finished top to match a 3mm profile edge.



PULLS

Pull Style	Pull Color	Pull Code
	Black Silver	12 13
	Black Silver	30 31

Locks

Randomly keyed locks "L" are standard on all storage units. Storage locks can be specified keyed alike "U" if required. Keyed alike option is field installed.

EDGES

Edge Profile	Edge Code
WoodPlus & 3mm 	Smooth S
	Reeded R
	NeoClassic E

For a closer look at edge styles, visit our website.

NOTES

For Customer Service Inquiries, please contact:

800.426.1202

360.394.1322 *fax*

www.magnadesign.com

STORAGE SUPPORTED WORKSTATIONS



Rectangle

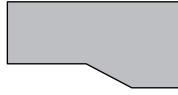
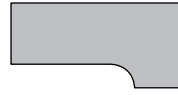

Bow Front

Extended
Corner AngledExtended
Corner Radius**HOW TO SPECIFY** 18**STORAGE SUPPORTED**

Rectangle 19

Bow Front 22

Extended Corner 22

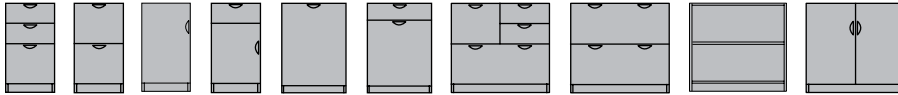

Storage Components 23

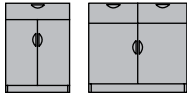

Storage Components

HOW TO

HOW TO SPECIFY A MOD EIGHT WORKSTATION WITH INDIVIDUAL COMPONENTS

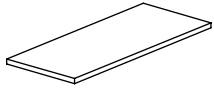
ONE: Select Desired Worksurface (p.19-22)

Rectangle

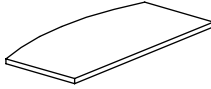

Bow Front

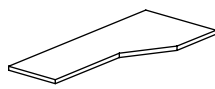

Extended Corner, Angled

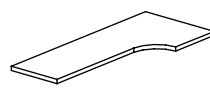

Extended Corner, Radius

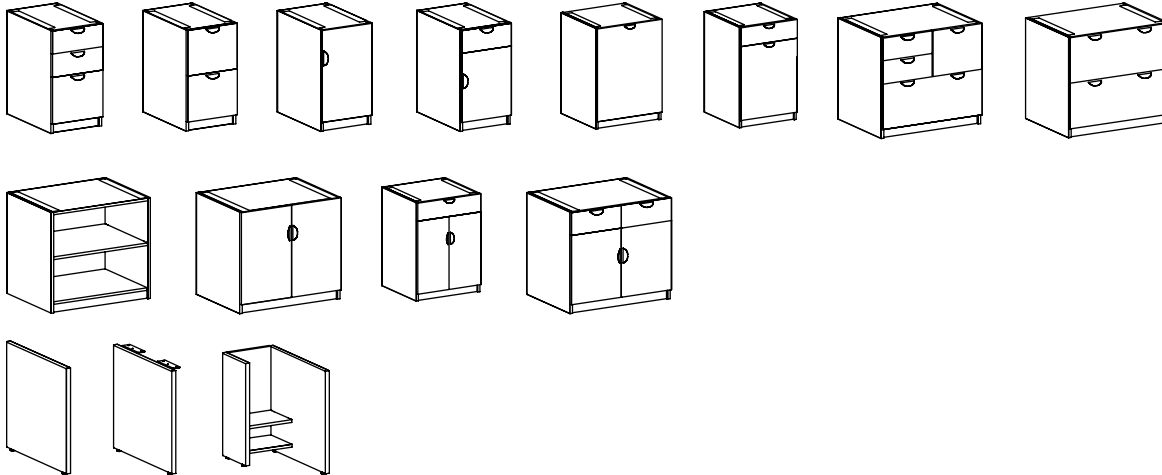
TWO: Select Left and Right Support Options (p.23-27)**THREE: Create a Workstation and Part Number**

Each unit will include a surface part number, a right hand support part number, and a left hand support part number.

Example: Rectangle surface with left hand end panel support and right hand storage support.

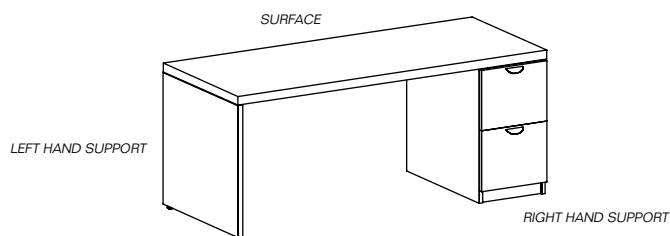

Surface: MOD8TRE3072-W-S-CU-CU

Left Hand Support: MOD8SEPB3029-W-S-CU

Right Hand Support: MOD8SC2F301529-N-12-CU-CU

SURFACE

PRODUCT

EDGE

FINISHES

A / B

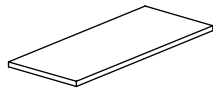

RECTANGLE

A	B	PRODUCT	Wood Plus	3mm	Detailed	Edge Profile	Surface	Edge
			P	W	D	See Below		
			\$	\$	\$			
15	15	MOD8TRE1515	219	275	489	<input type="checkbox"/>	<input type="checkbox"/>	<input type="checkbox"/>
15	21	MOD8TRE1521	230	287	501	<input type="checkbox"/>	<input type="checkbox"/>	<input type="checkbox"/>
15	24	MOD8TRE1524	230	287	501	<input type="checkbox"/>	<input type="checkbox"/>	<input type="checkbox"/>
15	30	MOD8TRE1530	272	329	542	<input type="checkbox"/>	<input type="checkbox"/>	<input type="checkbox"/>
15	36	MOD8TRE1536	302	359	572	<input type="checkbox"/>	<input type="checkbox"/>	<input type="checkbox"/>
15	42	MOD8TRE1542	307	363	577	<input type="checkbox"/>	<input type="checkbox"/>	<input type="checkbox"/>
15	48	MOD8TRE1548	307	363	577	<input type="checkbox"/>	<input type="checkbox"/>	<input type="checkbox"/>
15	54	MOD8TRE1554	437	609	707	<input type="checkbox"/>	<input type="checkbox"/>	<input type="checkbox"/>
15	60	MOD8TRE1560	437	609	707	<input type="checkbox"/>	<input type="checkbox"/>	<input type="checkbox"/>
15	66	MOD8TRE1566	478	534	763	<input type="checkbox"/>	<input type="checkbox"/>	<input type="checkbox"/>
15	72	MOD8TRE1572	478	534	763	<input type="checkbox"/>	<input type="checkbox"/>	<input type="checkbox"/>
24	15	MOD8TRE2415	219	275	489	<input type="checkbox"/>	<input type="checkbox"/>	<input type="checkbox"/>
24	21	MOD8TRE2421	230	287	501	<input type="checkbox"/>	<input type="checkbox"/>	<input type="checkbox"/>
24	24	MOD8TRE2424	230	287	501	<input type="checkbox"/>	<input type="checkbox"/>	<input type="checkbox"/>
24	30	MOD8TRE2430	272	329	542	<input type="checkbox"/>	<input type="checkbox"/>	<input type="checkbox"/>
24	36	MOD8TRE2436	302	359	572	<input type="checkbox"/>	<input type="checkbox"/>	<input type="checkbox"/>
24	42	MOD8TRE2442	307	363	577	<input type="checkbox"/>	<input type="checkbox"/>	<input type="checkbox"/>
24	48	MOD8TRE2448	307	363	577	<input type="checkbox"/>	<input type="checkbox"/>	<input type="checkbox"/>
24	54	MOD8TRE2454	437	609	707	<input type="checkbox"/>	<input type="checkbox"/>	<input type="checkbox"/>
24	60	MOD8TRE2460	437	609	707	<input type="checkbox"/>	<input type="checkbox"/>	<input type="checkbox"/>
24	66	MOD8TRE2466	478	534	763	<input type="checkbox"/>	<input type="checkbox"/>	<input type="checkbox"/>
24	72	MOD8TRE2472	478	534	763	<input type="checkbox"/>	<input type="checkbox"/>	<input type="checkbox"/>
24	78	MOD8TRE2478	482	539	788	<input type="checkbox"/>	<input type="checkbox"/>	<input type="checkbox"/>
24	84	MOD8TRE2484	482	539	788	<input type="checkbox"/>	<input type="checkbox"/>	<input type="checkbox"/>
24	90	MOD8TRE2490	593	650	899	<input type="checkbox"/>	<input type="checkbox"/>	<input type="checkbox"/>
24	96	MOD8TRE2496	593	650	899	<input type="checkbox"/>	<input type="checkbox"/>	<input type="checkbox"/>
24	102	MOD8TRE24102	743	800	1063	<input type="checkbox"/>	<input type="checkbox"/>	<input type="checkbox"/>
24	108	MOD8TRE24108	743	800	1063	<input type="checkbox"/>	<input type="checkbox"/>	<input type="checkbox"/>
24	114	MOD8TRE24114	743	800	1063	<input type="checkbox"/>	<input type="checkbox"/>	<input type="checkbox"/>
24	120	MOD8TRE24120	743	800	1063	<input type="checkbox"/>	<input type="checkbox"/>	<input type="checkbox"/>

RESOURCES

STORAGE SUPPORT COMPONENTS	23
OVERHEAD STORAGE	37
STORAGE TOWERS	51
ACCESSORIES	65
FINISHES	76

Rectangle surfaces 60 inches or larger require additional support. Contact Customer Service for more information.

OPTIONS

Grain Direction

Surface grain direction runs the length of the work-surface.

Optional Edge Inlay

A chrome or black edge inlay is available with Detailed edge options. Contact customer service for ordering information.

Grommets

To add factory installed grommets place a "G" after the edge profile code above and add \$56 list for each desk.

Surface Details

Dimension information and optional grommet locations are shown below.

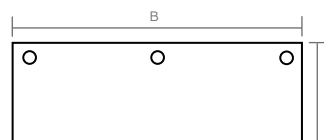

EDGES

Edge Profile		Edge Code
WoodPlus & 3mm		
	Smooth	S
	Reeded	R
	NeoClassic	E
Detailed		
	Radius	D
	Beveled	B
	Transitional	T
	Reeded	R
	Classic	C

For a closer look at edge styles, visit our website.

SURFACE

PRODUCT

EDGE

FINISHES

A / B

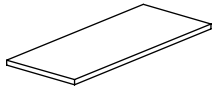

RECTANGLE

A	B	PRODUCT	Wood Plus	3mm	Detailed	Edge Profile	Surface	Edge
			P	W	D	See Below		
			\$	\$	\$			
30	15	MOD8TRE3015	260	317	531	<input type="checkbox"/>	<input type="checkbox"/>	<input type="checkbox"/>
30	21	MOD8TRE3021	272	329	542	<input type="checkbox"/>	<input type="checkbox"/>	<input type="checkbox"/>
30	24	MOD8TRE3024	272	329	542	<input type="checkbox"/>	<input type="checkbox"/>	<input type="checkbox"/>
30	30	MOD8TRE3030	289	346	560	<input type="checkbox"/>	<input type="checkbox"/>	<input type="checkbox"/>
30	36	MOD8TRE3036	312	369	583	<input type="checkbox"/>	<input type="checkbox"/>	<input type="checkbox"/>
30	42	MOD8TRE3042	359	415	629	<input type="checkbox"/>	<input type="checkbox"/>	<input type="checkbox"/>
30	48	MOD8TRE3048	359	415	629	<input type="checkbox"/>	<input type="checkbox"/>	<input type="checkbox"/>
30	54	MOD8TRE3054	445	502	715	<input type="checkbox"/>	<input type="checkbox"/>	<input type="checkbox"/>
30	60	MOD8TRE3060	445	502	730	<input type="checkbox"/>	<input type="checkbox"/>	<input type="checkbox"/>
30	66	MOD8TRE3066	490	547	776	<input type="checkbox"/>	<input type="checkbox"/>	<input type="checkbox"/>
30	72	MOD8TRE3072	490	547	776	<input type="checkbox"/>	<input type="checkbox"/>	<input type="checkbox"/>
30	78	MOD8TRE3078	555	611	861	<input type="checkbox"/>	<input type="checkbox"/>	<input type="checkbox"/>
30	84	MOD8TRE3084	555	611	861	<input type="checkbox"/>	<input type="checkbox"/>	<input type="checkbox"/>
30	90	MOD8TRE3090	669	726	975	<input type="checkbox"/>	<input type="checkbox"/>	<input type="checkbox"/>
30	96	MOD8TRE3096	669	726	975	<input type="checkbox"/>	<input type="checkbox"/>	<input type="checkbox"/>
30	102	MOD8TRE30102	773	830	1093	<input type="checkbox"/>	<input type="checkbox"/>	<input type="checkbox"/>
30	108	MOD8TRE30108	773	830	1093	<input type="checkbox"/>	<input type="checkbox"/>	<input type="checkbox"/>
30	114	MOD8TRE30114	773	830	1093	<input type="checkbox"/>	<input type="checkbox"/>	<input type="checkbox"/>
30	120	MOD8TRE30120	773	830	1093	<input type="checkbox"/>	<input type="checkbox"/>	<input type="checkbox"/>

RESOURCES

STORAGE SUPPORT COMPONENTS	23
OVERHEAD STORAGE	37
STORAGE TOWERS	51
ACCESSORIES	65
FINISHES	76

Rectangle surfaces 60 inches or larger require additional support. Contact Customer Service for more information.

OPTIONS

Grain Direction

Surface grain direction runs the length of the work-surface.

Optional Edge Inlay

A chrome or black edge inlay is available with Detailed edge options. Contact customer service for ordering information.

Grommets

To add factory installed grommets place a "G" after the edge profile code above and add \$56 list for each desk.

Surface Details

Dimension information and optional grommet locations are shown below.

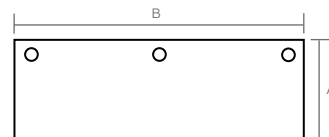

EDGES

Edge Profile**Edge Code****WoodPlus & 3mm**

Smooth

S

Reeded

R

NeoClassic

E**Detailed**

Radius

D

Beveled

B

Transitional

T

Reeded

R

Classic

C

For a closer look at edge styles, visit our website.

SURFACE

PRODUCT

EDGE

FINISHES

A / B

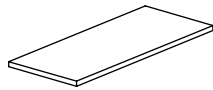

RECTANGLE

A	B	PRODUCT	Wood Plus	3mm	Detailed	Edge Profile	Surface	Edge
			P	W	D	See Below		
			\$	\$	\$			
36	24	MOD8TRE3624	275	332	546	<input type="checkbox"/>	<input type="checkbox"/>	<input type="checkbox"/>
36	30	MOD8TRE3630	335	392	606	<input type="checkbox"/>	<input type="checkbox"/>	<input type="checkbox"/>
36	36	MOD8TRE3636	335	392	606	<input type="checkbox"/>	<input type="checkbox"/>	<input type="checkbox"/>
36	42	MOD8TRE3642	390	446	660	<input type="checkbox"/>	<input type="checkbox"/>	<input type="checkbox"/>
36	48	MOD8TRE3648	390	446	660	<input type="checkbox"/>	<input type="checkbox"/>	<input type="checkbox"/>
36	54	MOD8TRE3654	491	548	762	<input type="checkbox"/>	<input type="checkbox"/>	<input type="checkbox"/>
36	60	MOD8TRE3660	491	548	777	<input type="checkbox"/>	<input type="checkbox"/>	<input type="checkbox"/>
36	66	MOD8TRE3666	506	563	792	<input type="checkbox"/>	<input type="checkbox"/>	<input type="checkbox"/>
36	72	MOD8TRE3672	513	570	799	<input type="checkbox"/>	<input type="checkbox"/>	<input type="checkbox"/>
36	78	MOD8TRE3678	616	673	922	<input type="checkbox"/>	<input type="checkbox"/>	<input type="checkbox"/>
36	84	MOD8TRE3684	616	673	922	<input type="checkbox"/>	<input type="checkbox"/>	<input type="checkbox"/>
36	90	MOD8TRE3690	741	797	1047	<input type="checkbox"/>	<input type="checkbox"/>	<input type="checkbox"/>
36	96	MOD8TRE3696	741	797	1047	<input type="checkbox"/>	<input type="checkbox"/>	<input type="checkbox"/>
36	102	MOD8TRE36102	973	1030	1293	<input type="checkbox"/>	<input type="checkbox"/>	<input type="checkbox"/>
36	108	MOD8TRE36108	973	1030	1293	<input type="checkbox"/>	<input type="checkbox"/>	<input type="checkbox"/>
36	114	MOD8TRE36114	973	1030	1293	<input type="checkbox"/>	<input type="checkbox"/>	<input type="checkbox"/>
36	120	MOD8TRE36120	973	1030	1293	<input type="checkbox"/>	<input type="checkbox"/>	<input type="checkbox"/>

RESOURCES

STORAGE SUPPORT COMPONENTS	23
OVERHEAD STORAGE	37
STORAGE TOWERS	51
ACCESSORIES	65
FINISHES	76

Rectangle surfaces 60 inches or larger require additional support. Contact Customer Service for more information.

OPTIONS

Grain Direction

Surface grain direction runs the length of the work-surface.

Optional Edge Inlay

A chrome or black edge inlay is available with Detailed edge options. Contact customer service for ordering information.

Grommets

To add factory installed grommets place a "G" after the edge profile code above and add \$56 list for each desk.

Surface Details

Dimension information and optional grommet locations are shown below.

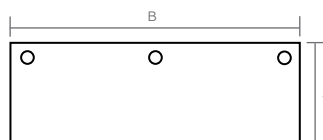

EDGES

Edge Profile		Edge Code
WoodPlus & 3mm		
	Smooth	S
	Reeded	R
	NeoClassic	E
Detailed		
	Radius	D
	Beveled	B
	Transitional	T
	Reeded	R
	Classic	C

For a closer look at edge styles, visit our website.

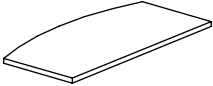
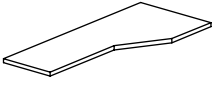
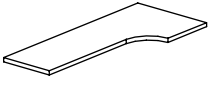
SURFACE	A / B	PRODUCT			EDGE			FINISHES			
		Depth C	Depth D	Left=L Right=R	Wood Plus	3mm	Detailed	Edge Profile	Surface	Edge	
 BOW FRONT	36 72	MOD8TBF3672	-	-	-	\$ 752	\$ 951	\$ 1241	<input type="checkbox"/>	<input type="checkbox"/>	<input type="checkbox"/>
	36 78	MOD8TBF3678	-	-	-	981	1186	1519	<input type="checkbox"/>	<input type="checkbox"/>	<input type="checkbox"/>
	36 84	MOD8TBF3684	-	-	-	981	1186	1519	<input type="checkbox"/>	<input type="checkbox"/>	<input type="checkbox"/>
	42 72	MOD8TBF4272	-	-	-	873	1071	1361	<input type="checkbox"/>	<input type="checkbox"/>	<input type="checkbox"/>
	42 78	MOD8TBF4278	-	-	-	1110	1315	1649	<input type="checkbox"/>	<input type="checkbox"/>	<input type="checkbox"/>
	42 84	MOD8TBF4284	-	-	-	1110	1315	1649	<input type="checkbox"/>	<input type="checkbox"/>	<input type="checkbox"/>
	36 72	MOD8TAC3672	24	<input type="checkbox"/>	<input type="checkbox"/>	1276	1474	1764	<input type="checkbox"/>	<input type="checkbox"/>	<input type="checkbox"/>
	36 78	MOD8TAC3678	24	<input type="checkbox"/>	<input type="checkbox"/>	1492	1696	2030	<input type="checkbox"/>	<input type="checkbox"/>	<input type="checkbox"/>
	36 84	MOD8TAC3684	24	<input type="checkbox"/>	<input type="checkbox"/>	1492	1696	2030	<input type="checkbox"/>	<input type="checkbox"/>	<input type="checkbox"/>
 EXTENDED CORNER, ANGLED <i>Right Hand Shown</i>	42 72	MOD8TAC4272	<input type="checkbox"/>	<input type="checkbox"/>	<input type="checkbox"/>	1406	1605	1895	<input type="checkbox"/>	<input type="checkbox"/>	<input type="checkbox"/>
	42 78	MOD8TAC4278	<input type="checkbox"/>	<input type="checkbox"/>	<input type="checkbox"/>	1631	1836	2170	<input type="checkbox"/>	<input type="checkbox"/>	<input type="checkbox"/>
	42 84	MOD8TAC4284	<input type="checkbox"/>	<input type="checkbox"/>	<input type="checkbox"/>	1631	1836	2170	<input type="checkbox"/>	<input type="checkbox"/>	<input type="checkbox"/>
	36 72	MOD8TRC3672	24	<input type="checkbox"/>	<input type="checkbox"/>	1378	1577	1867	<input type="checkbox"/>	<input type="checkbox"/>	<input type="checkbox"/>
	36 78	MOD8TRC3678	24	<input type="checkbox"/>	<input type="checkbox"/>	1594	1799	2133	<input type="checkbox"/>	<input type="checkbox"/>	<input type="checkbox"/>
	36 84	MOD8TRC3684	24	<input type="checkbox"/>	<input type="checkbox"/>	1594	1799	2133	<input type="checkbox"/>	<input type="checkbox"/>	<input type="checkbox"/>
 EXTENDED CORNER, RADIUS <i>Right Hand Shown</i>	42 72	MOD8TRC4272	<input type="checkbox"/>	<input type="checkbox"/>	<input type="checkbox"/>	1511	1710	2000	<input type="checkbox"/>	<input type="checkbox"/>	<input type="checkbox"/>
	42 78	MOD8TRC4278	<input type="checkbox"/>	<input type="checkbox"/>	<input type="checkbox"/>	1732	1936	2270	<input type="checkbox"/>	<input type="checkbox"/>	<input type="checkbox"/>
	42 84	MOD8TRC4284	<input type="checkbox"/>	<input type="checkbox"/>	<input type="checkbox"/>	1732	1936	2270	<input type="checkbox"/>	<input type="checkbox"/>	<input type="checkbox"/>
				<input type="checkbox"/>	<input type="checkbox"/>	<input type="checkbox"/>				<input type="checkbox"/>	<input type="checkbox"/>

RESOURCES

STORAGE SUPPORT COMPONENTS	23
OVERHEAD STORAGE	37
STORAGE TOWERS	51
ACCESSORIES	65
FINISHES	76

42 inch deep Extended Corner with a 24 inch deep extension "C" can only be specified with a 24 inch deep docking side "D"

Dimensions

A = Depth
B = Width
C = Extension Depth
D = Docking Side

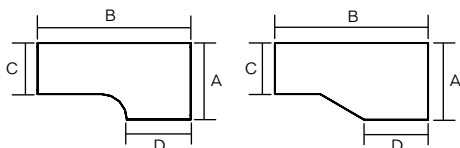

OPTIONS

Grain Direction

Surface grain direction runs the length of the work-surface.

Optional Edge Inlay

A chrome or black edge inlay is available with Detailed edge options. Contact customer service for ordering information.

Grommets







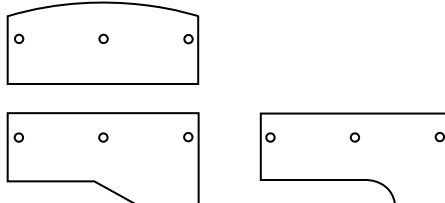

To add factory installed grommets place a "G" after the edge profile code above and add \$56 list for each desk.

Surface Details

Optional grommet locations are shown below.



EDGES

Edge Profile		Edge Code
WoodPlus & 3mm		
	Smooth	S
	Reeded	R
	NeoClassic	E
Detailed		
	Radius	D
	Beveled	B
	Transitional	T
	Reeded	R
	Classic	C

For a closer look at edge styles, visit our website.

STORAGE SUPPORT CABINETS

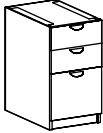
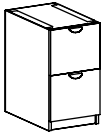
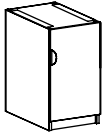
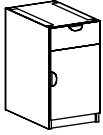

		PRODUCT		OPTIONS		FINISHES	
D / W / H		Left = L Right = R	Price	Lock = L Alike = U	Pull	Case	Face
				See Below	See Below		
	24 15 29		\$				
	30 15 29						
TWO BOX FILE							
	24 15 29		993				
	30 15 29		993				
TWO FILE							
	24 15 29	<input type="checkbox"/>	941	<input type="checkbox"/>			
	24 21 29	<input type="checkbox"/>	941	<input type="checkbox"/>			
	30 15 29	<input type="checkbox"/>	941	<input type="checkbox"/>			
	24 15 36	<input type="checkbox"/>	1034	<input type="checkbox"/>			
	24 21 36	<input type="checkbox"/>	1034	<input type="checkbox"/>			
SINGLE DOOR <i>Right Hand Shown</i>							
	24 15 29	<input type="checkbox"/>	993	<input type="checkbox"/>			
	24 21 29	<input type="checkbox"/>	1102	<input type="checkbox"/>			
	30 15 29	<input type="checkbox"/>	993	<input type="checkbox"/>			
	24 15 36	<input type="checkbox"/>	1092	<input type="checkbox"/>			
	24 21 36	<input type="checkbox"/>	1196	<input type="checkbox"/>			
BOX / SINGLE DOOR <i>Right Hand Shown</i>							

RESOURCES

STORAGE ACCESSORIES	69
FINISHES	76

Support pedestals include reveal strips and are pre-drilled for attaching worksurfaces.

PULLS

Pull Style	Pull Color	Pull Code
	Black	12
	Silver	13
	Black	30
	Silver	31
	Touchlatch <i>Door units only</i>	NN

Locks

Randomly keyed locks "L" are standard on all storage units. Storage locks can be specified keyed alike "U" if required. Keyed alike option is field installed.

STORAGE SUPPORT CABINETS

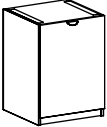
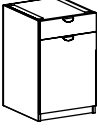
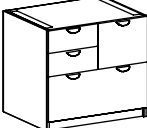
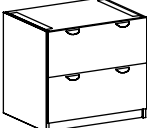
		PRODUCT		OPTIONS		FINISHES	
D / W / H		Left = L Right = R	Price	Lock = L Alike = U	Pull	Case	Face
			\$	See Below	See Below		
 RECYCLE	24 21 29		993	<input type="checkbox"/>	<input type="checkbox"/>	<input type="checkbox"/>	<input type="checkbox"/>
	24 24 29		993	<input type="checkbox"/>	<input type="checkbox"/>	<input type="checkbox"/>	<input type="checkbox"/>
	24 21 36		1092	<input type="checkbox"/>	<input type="checkbox"/>	<input type="checkbox"/>	<input type="checkbox"/>
	24 24 36		1092	<input type="checkbox"/>	<input type="checkbox"/>	<input type="checkbox"/>	<input type="checkbox"/>
 BOX / RECYCLE	24 21 29		1154	<input type="checkbox"/>	<input type="checkbox"/>	<input type="checkbox"/>	<input type="checkbox"/>
	24 24 29		1154	<input type="checkbox"/>	<input type="checkbox"/>	<input type="checkbox"/>	<input type="checkbox"/>
	24 21 36		1254	<input type="checkbox"/>	<input type="checkbox"/>	<input type="checkbox"/>	<input type="checkbox"/>
	24 24 36		1254	<input type="checkbox"/>	<input type="checkbox"/>	<input type="checkbox"/>	<input type="checkbox"/>
 COMBO <i>Right Hand Shown</i>	24 30 29	<input type="checkbox"/>	1704	<input type="checkbox"/>	<input type="checkbox"/>	<input type="checkbox"/>	<input type="checkbox"/>
	30 30 29	<input type="checkbox"/>	1704	<input type="checkbox"/>	<input type="checkbox"/>	<input type="checkbox"/>	<input type="checkbox"/>
 LATERAL	24 30 29		1473	<input type="checkbox"/>	<input type="checkbox"/>	<input type="checkbox"/>	<input type="checkbox"/>
	24 36 29		1473	<input type="checkbox"/>	<input type="checkbox"/>	<input type="checkbox"/>	<input type="checkbox"/>
	30 30 36		1473	<input type="checkbox"/>	<input type="checkbox"/>	<input type="checkbox"/>	<input type="checkbox"/>
	30 36 36		1473	<input type="checkbox"/>	<input type="checkbox"/>	<input type="checkbox"/>	<input type="checkbox"/>

RESOURCES

PULLS

STORAGE ACCESSORIES

69

FINISHES

76

Pull Style	Pull Color	Pull Code
------------	------------	-----------



Black	12
Silver	13



Black	30
Silver	31

Locks

Randomly keyed locks "L" are standard on all storage units. Storage locks can be specified keyed alike "U" if required. Keyed alike option is field installed.

STORAGE SUPPORT CABINETS

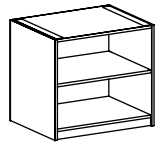

OPEN

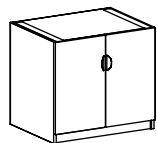

TWO DOOR

D / W / H			PRODUCT	Price	Lock = L Alike = U See Below	Pull See Below	Case	Face
				\$				
15	24	29	MOD8SCOP152429	600	-	-	<input type="checkbox"/> <input type="checkbox"/>	-
15	30	29	MOD8SCOP153029	614	-	-	<input type="checkbox"/> <input type="checkbox"/>	-
15	36	29	MOD8SCOP153629	728	-	-	<input type="checkbox"/> <input type="checkbox"/>	-
24	15	29	MOD8SCOP241529	657	-	-	<input type="checkbox"/> <input type="checkbox"/>	-
24	24	29	MOD8SCOP242429	657	-	-	<input type="checkbox"/> <input type="checkbox"/>	-
24	30	29	MOD8SCOP243029	695	-	-	<input type="checkbox"/> <input type="checkbox"/>	-
24	36	29	MOD8SCOP243629	695	-	-	<input type="checkbox"/> <input type="checkbox"/>	-
30	15	29	MOD8SCOP301529	722	-	-	<input type="checkbox"/> <input type="checkbox"/>	-
30	24	29	MOD8SCOP302429	722	-	-	<input type="checkbox"/> <input type="checkbox"/>	-
30	30	29	MOD8SCOP303029	760	-	-	<input type="checkbox"/> <input type="checkbox"/>	-
30	36	29	MOD8SCOP303629	760	-	-	<input type="checkbox"/> <input type="checkbox"/>	-
15	24	29	MOD8SC2D152429	897	<input type="checkbox"/>	<input type="checkbox"/> <input type="checkbox"/>	<input type="checkbox"/> <input type="checkbox"/>	<input type="checkbox"/> <input type="checkbox"/>
15	30	29	MOD8SC2D153029	955	<input type="checkbox"/>	<input type="checkbox"/> <input type="checkbox"/>	<input type="checkbox"/> <input type="checkbox"/>	<input type="checkbox"/> <input type="checkbox"/>
15	36	29	MOD8SC2D153629	955	<input type="checkbox"/>	<input type="checkbox"/> <input type="checkbox"/>	<input type="checkbox"/> <input type="checkbox"/>	<input type="checkbox"/> <input type="checkbox"/>
24	24	29	MOD8SC2D242429	941	<input type="checkbox"/>	<input type="checkbox"/> <input type="checkbox"/>	<input type="checkbox"/> <input type="checkbox"/>	<input type="checkbox"/> <input type="checkbox"/>
24	30	29	MOD8SC2D243029	955	<input type="checkbox"/>	<input type="checkbox"/> <input type="checkbox"/>	<input type="checkbox"/> <input type="checkbox"/>	<input type="checkbox"/> <input type="checkbox"/>
24	36	29	MOD8SC2D243629	955	<input type="checkbox"/>	<input type="checkbox"/> <input type="checkbox"/>	<input type="checkbox"/> <input type="checkbox"/>	<input type="checkbox"/> <input type="checkbox"/>
30	24	29	MOD8SC2D302429	941	<input type="checkbox"/>	<input type="checkbox"/> <input type="checkbox"/>	<input type="checkbox"/> <input type="checkbox"/>	<input type="checkbox"/> <input type="checkbox"/>
30	30	29	MOD8SC2D303029	955	<input type="checkbox"/>	<input type="checkbox"/> <input type="checkbox"/>	<input type="checkbox"/> <input type="checkbox"/>	<input type="checkbox"/> <input type="checkbox"/>
30	36	29	MOD8SC2D303629	955	<input type="checkbox"/>	<input type="checkbox"/> <input type="checkbox"/>	<input type="checkbox"/> <input type="checkbox"/>	<input type="checkbox"/> <input type="checkbox"/>
24	24	36	MOD8SC2D242436	1034	<input type="checkbox"/>	<input type="checkbox"/> <input type="checkbox"/>	<input type="checkbox"/> <input type="checkbox"/>	<input type="checkbox"/> <input type="checkbox"/>
24	30	36	MOD8SC2D243036	1050	<input type="checkbox"/>	<input type="checkbox"/> <input type="checkbox"/>	<input type="checkbox"/> <input type="checkbox"/>	<input type="checkbox"/> <input type="checkbox"/>
24	36	36	MOD8SC2D243636	1050	<input type="checkbox"/>	<input type="checkbox"/> <input type="checkbox"/>	<input type="checkbox"/> <input type="checkbox"/>	<input type="checkbox"/> <input type="checkbox"/>

RESOURCES

STORAGE ACCESSORIES

69

FINISHES

76

PULLS

Pull Style	Pull Color	Pull Code
	Black	12
	Silver	13
	Black	30
	Silver	31
Touchlatch <i>Door units only</i>		NN

Locks

Randomly keyed locks "L" are standard on all storage units. Storage locks can be specified keyed alike "U" if required. Keyed alike option is field installed.

STORAGE SUPPORT CABINETS

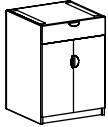

BOX / TWO DOOR

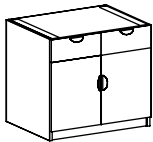

TWO BOX / TWO DOOR

D / W / H

D / W / H	PRODUCT	Price	Lock= L	Pull	Case	Face
			Alike= U			
		\$	See Below	See Below		
24 24 29	MOD8SCB2D242429	1102	<input type="checkbox"/>	<input type="checkbox"/>	<input type="checkbox"/>	<input type="checkbox"/>
24 24 36	MOD8SCB2D242436	1196	<input type="checkbox"/>	<input type="checkbox"/>	<input type="checkbox"/>	<input type="checkbox"/>
24 30 29	MOD8SC2B2D243029	1278	<input type="checkbox"/>	<input type="checkbox"/>	<input type="checkbox"/>	<input type="checkbox"/>
24 36 29	MOD8SC2B2D243629	1278	<input type="checkbox"/>	<input type="checkbox"/>	<input type="checkbox"/>	<input type="checkbox"/>
24 30 36	MOD8SC2B2D243036	1374	<input type="checkbox"/>	<input type="checkbox"/>	<input type="checkbox"/>	<input type="checkbox"/>
24 36 36	MOD8SC2B2D243636	1374	<input type="checkbox"/>	<input type="checkbox"/>	<input type="checkbox"/>	<input type="checkbox"/>

RESOURCES

PULLS

STORAGE ACCESSORIES

69

FINISHES

76

Pull Style	Pull Color	Pull Code
	Black	12
	Silver	13
	Black	30
	Silver	31

Locks

Randomly keyed locks "L" are standard on all storage units. Storage locks can be specified keyed alike "U" if required. Keyed alike option is field installed.

STORAGE SUPPORT CABINETS

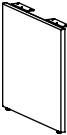
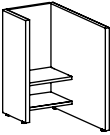
	D / W / H	PRODUCT	Left = L Right = R	EDGE			FINISHES
				Wood Plus	3mm	Edge Profile	
				P	W		
				\$	\$		
 END PANEL	- 12 29	MOD8SEP1229	-	198	225	S	<input type="checkbox"/>
	- 14 29	MOD8SEP1429	-	231	258	S	<input type="checkbox"/>
	- 24 29	MOD8SEP2429	-	252	287	S	<input type="checkbox"/>
	- 30 29	MOD8SEP3029	-	274	309	S	<input type="checkbox"/>
	- 36 29	MOD8SEP3629	-	300	334	S	<input type="checkbox"/>
	- 42 29	MOD8SEP4229	-	318	353	S	<input type="checkbox"/>
 END PANEL W/BACKET	- 12 29	MOD8SEPB1229	-	290	317	S	<input type="checkbox"/>
	- 14 29	MOD8SEPB1429	-	327	354	S	<input type="checkbox"/>
	- 24 29	MOD8SEPB2429	-	353	387	S	<input type="checkbox"/>
	- 30 29	MOD8SEPB3029	-	378	413	S	<input type="checkbox"/>
	- 36 29	MOD8SEPB3629	-	406	441	S	<input type="checkbox"/>
	- 42 29	MOD8SEPB4229	-	430	465	S	<input type="checkbox"/>
 PEDESTAL BLANK	24 15 29	MOD8SCBLK241529	<input type="checkbox"/>	687	721	S	<input type="checkbox"/>
	30 15 29	MOD8SCBLK301529	<input type="checkbox"/>	711	745	S	<input type="checkbox"/>
	36 15 29	MOD8SCBLK361529	<input type="checkbox"/>	748	782	S	<input type="checkbox"/>
			<input type="checkbox"/>				<input type="checkbox"/>

RESOURCES

STORAGE ACCESSORIES

69

FINISHES

76

MODESTY PANEL

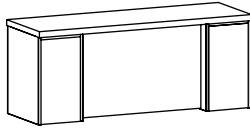

INSET

A / B

29 24
29 30
29 36
29 42
29 48
29 54
29 60
29 66
29 72
29 78
29 84
29 90
29 96
29 102
29 108
29 114
29 120

PRODUCT	EDGE			FINISHES	
	Grain	Wood Plus	3mm		Edge Profile
	Horz = H Vert = V	P	W	See Below	
		\$	\$		
MOD8MPI24	<input type="checkbox"/>	195	227	S	<input type="checkbox"/> <input type="checkbox"/>
MOD8MPI30	<input type="checkbox"/>	195	227	S	<input type="checkbox"/> <input type="checkbox"/>
MOD8MPI36	<input type="checkbox"/>	195	227	S	<input type="checkbox"/> <input type="checkbox"/>
MOD8MPI42	<input type="checkbox"/>	195	227	S	<input type="checkbox"/> <input type="checkbox"/>
MOD8MPI48	<input type="checkbox"/>	195	227	S	<input type="checkbox"/> <input type="checkbox"/>
MOD8MPI54	<input type="checkbox"/>	195	227	S	<input type="checkbox"/> <input type="checkbox"/>
MOD8MPI60	<input type="checkbox"/>	195	227	S	<input type="checkbox"/> <input type="checkbox"/>
MOD8MPI66	H	195	227	S	<input type="checkbox"/> <input type="checkbox"/>
MOD8MPI72	H	195	227	S	<input type="checkbox"/> <input type="checkbox"/>
MOD8MPI78	H	195	227	S	<input type="checkbox"/> <input type="checkbox"/>
MOD8MPI84	H	195	227	S	<input type="checkbox"/> <input type="checkbox"/>
MOD8MPI90	H	195	227	S	<input type="checkbox"/> <input type="checkbox"/>
MOD8MPI96	H	195	227	S	<input type="checkbox"/> <input type="checkbox"/>
MOD8MPI102	H	195	227	S	<input type="checkbox"/> <input type="checkbox"/>
MOD8MPI108	H	195	227	S	<input type="checkbox"/> <input type="checkbox"/>
MOD8MPI114	H	195	227	S	<input type="checkbox"/> <input type="checkbox"/>
MOD8MPI120	H	195	227	S	<input type="checkbox"/> <input type="checkbox"/>

PRODUCT NOTES

Vertical grain modesty panel available at 60-inches long or less to parallel pedestal and end panel grain direction.

NOTES

For Customer Service Inquiries, please contact:

800.426.1202

360.394.1322 *fax*

www.magnadesign.com

SECONDARY SURFACES



Rectangle



Bullet

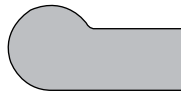

P Top



Tear Drop



Half Round



Quarter Round

SECONDARY SURFACES

Return	32
Bridge	33
Extension	34

RETURN

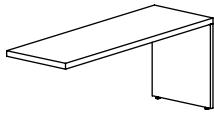

RECTANGLE

A / B

A / B	PRODUCT	Left=L Right=R	Modesty Panel Full=F Half=H No=N	EDGE			Edge Profile See Below	FINISHES		
				Wood Plus P	3mm W	Detailed W		Surface	Edge	Base
22 30	MOD8RRE2230	<input type="checkbox"/>	<input type="checkbox"/>	\$ 705	\$ 815	\$ 1008	<input type="checkbox"/>	<input type="checkbox"/>	<input type="checkbox"/>	<input type="checkbox"/>
22 36	MOD8RRE2236	<input type="checkbox"/>	<input type="checkbox"/>	705	815	1008	<input type="checkbox"/>	<input type="checkbox"/>	<input type="checkbox"/>	<input type="checkbox"/>
22 42	MOD8RRE2242	<input type="checkbox"/>	<input type="checkbox"/>	735	845	1038	<input type="checkbox"/>	<input type="checkbox"/>	<input type="checkbox"/>	<input type="checkbox"/>
22 48	MOD8RRE2248	<input type="checkbox"/>	<input type="checkbox"/>	745	855	1048	<input type="checkbox"/>	<input type="checkbox"/>	<input type="checkbox"/>	<input type="checkbox"/>
22 54	MOD8RRE2254	<input type="checkbox"/>	<input type="checkbox"/>	787	897	1090	<input type="checkbox"/>	<input type="checkbox"/>	<input type="checkbox"/>	<input type="checkbox"/>
22 60	MOD8RRE2260	<input type="checkbox"/>	<input type="checkbox"/>	824	935	1143	<input type="checkbox"/>	<input type="checkbox"/>	<input type="checkbox"/>	<input type="checkbox"/>
22 66	MOD8RRE2266	<input type="checkbox"/>	<input type="checkbox"/>	847	958	1166	<input type="checkbox"/>	<input type="checkbox"/>	<input type="checkbox"/>	<input type="checkbox"/>
22 72	MOD8RRE2272	<input type="checkbox"/>	<input type="checkbox"/>	879	990	1198	<input type="checkbox"/>	<input type="checkbox"/>	<input type="checkbox"/>	<input type="checkbox"/>
24 30	MOD8RRE2430	<input type="checkbox"/>	<input type="checkbox"/>	705	815	1008	<input type="checkbox"/>	<input type="checkbox"/>	<input type="checkbox"/>	<input type="checkbox"/>
24 36	MOD8RRE2436	<input type="checkbox"/>	<input type="checkbox"/>	705	815	1008	<input type="checkbox"/>	<input type="checkbox"/>	<input type="checkbox"/>	<input type="checkbox"/>
24 42	MOD8RRE2442	<input type="checkbox"/>	<input type="checkbox"/>	735	845	1038	<input type="checkbox"/>	<input type="checkbox"/>	<input type="checkbox"/>	<input type="checkbox"/>
24 48	MOD8RRE2448	<input type="checkbox"/>	<input type="checkbox"/>	745	855	1048	<input type="checkbox"/>	<input type="checkbox"/>	<input type="checkbox"/>	<input type="checkbox"/>
24 54	MOD8RRE2454	<input type="checkbox"/>	<input type="checkbox"/>	787	897	1090	<input type="checkbox"/>	<input type="checkbox"/>	<input type="checkbox"/>	<input type="checkbox"/>
24 60	MOD8RRE2460	<input type="checkbox"/>	<input type="checkbox"/>	824	935	1143	<input type="checkbox"/>	<input type="checkbox"/>	<input type="checkbox"/>	<input type="checkbox"/>
24 66	MOD8RRE2466	<input type="checkbox"/>	<input type="checkbox"/>	847	958	1166	<input type="checkbox"/>	<input type="checkbox"/>	<input type="checkbox"/>	<input type="checkbox"/>
24 72	MOD8RRE2472	<input type="checkbox"/>	<input type="checkbox"/>	879	990	1198	<input type="checkbox"/>	<input type="checkbox"/>	<input type="checkbox"/>	<input type="checkbox"/>
30 36	MOD8RRE3036	<input type="checkbox"/>	<input type="checkbox"/>	897	1007	1199	<input type="checkbox"/>	<input type="checkbox"/>	<input type="checkbox"/>	<input type="checkbox"/>
30 42	MOD8RRE3042	<input type="checkbox"/>	<input type="checkbox"/>	897	1007	1199	<input type="checkbox"/>	<input type="checkbox"/>	<input type="checkbox"/>	<input type="checkbox"/>
30 48	MOD8RRE3048	<input type="checkbox"/>	<input type="checkbox"/>	924	1034	1227	<input type="checkbox"/>	<input type="checkbox"/>	<input type="checkbox"/>	<input type="checkbox"/>
30 54	MOD8RRE3054	<input type="checkbox"/>	<input type="checkbox"/>	940	1049	1242	<input type="checkbox"/>	<input type="checkbox"/>	<input type="checkbox"/>	<input type="checkbox"/>
30 60	MOD8RRE3060	<input type="checkbox"/>	<input type="checkbox"/>	948	1058	1266	<input type="checkbox"/>	<input type="checkbox"/>	<input type="checkbox"/>	<input type="checkbox"/>
30 66	MOD8RRE3066	<input type="checkbox"/>	<input type="checkbox"/>	970	1080	1288	<input type="checkbox"/>	<input type="checkbox"/>	<input type="checkbox"/>	<input type="checkbox"/>
30 72	MOD8RRE3072	<input type="checkbox"/>	<input type="checkbox"/>	996	1107	1315	<input type="checkbox"/>	<input type="checkbox"/>	<input type="checkbox"/>	<input type="checkbox"/>
36 42	MOD8RRE3642	<input type="checkbox"/>	<input type="checkbox"/>	1026	1136	1329	<input type="checkbox"/>	<input type="checkbox"/>	<input type="checkbox"/>	<input type="checkbox"/>
36 48	MOD8RRE3648	<input type="checkbox"/>	<input type="checkbox"/>	1026	1136	1329	<input type="checkbox"/>	<input type="checkbox"/>	<input type="checkbox"/>	<input type="checkbox"/>
36 54	MOD8RRE3654	<input type="checkbox"/>	<input type="checkbox"/>	1054	1164	1356	<input type="checkbox"/>	<input type="checkbox"/>	<input type="checkbox"/>	<input type="checkbox"/>
36 60	MOD8RRE3660	<input type="checkbox"/>	<input type="checkbox"/>	1076	1187	1395	<input type="checkbox"/>	<input type="checkbox"/>	<input type="checkbox"/>	<input type="checkbox"/>
36 66	MOD8RRE3666	<input type="checkbox"/>	<input type="checkbox"/>	1130	1241	1449	<input type="checkbox"/>	<input type="checkbox"/>	<input type="checkbox"/>	<input type="checkbox"/>
36 72	MOD8RRE3672	<input type="checkbox"/>	<input type="checkbox"/>	1180	1291	1499	<input type="checkbox"/>	<input type="checkbox"/>	<input type="checkbox"/>	<input type="checkbox"/>

RESOURCES

SHELL DESKS	05
STORAGE SUPPORTED	17
OVERHEAD STORAGE	37
STORAGE TOWERS	51
ACCESSORIES	65
FINISHES	76

Designate Left/Right Return when seated at Primary desk.

Returns ship with required mounting hardware to attach Returns to other surfaces.

OPTIONS

Grain Direction

Surface grain direction runs the length of the work-surface.

Modesty Panel ships standard with horizontal grain direction. Vertical grain option available for surfaces under 60-inches, contact customer service to order.

Optional Edge Inlay

A chrome or black edge inlay is available with Detailed edge options. Contact customer service for ordering information.

Grommets

To add factory installed grommets place a "G" after the edge profile code above and add \$56 list for each desk.

Grommet & Modesty Location

Optional grommet locations shown.

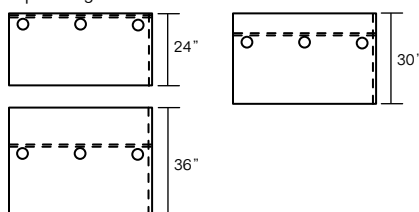

EDGES

Edge Profile**Edge Code****WoodPlus & 3mm**

Smooth

S

Reeded

R

NeoClassic

E**Detailed**

Radius

D

Beveled

B

Transitional

T

Reeded

R

Classic

C

For a closer look at edge styles, visit our website.

BRIDGE

A / B	PRODUCT		EDGE				FINISHES			
			Grain Side = S Front = F	Modesty Panel Full = F Half = H No = N	Wood Plus P	3mm W	Detailed D	Edge Profile See Below	Surface	Edge
					\$	\$	\$			
22 30	MOD8SBR2230	<input type="checkbox"/>	<input type="checkbox"/>	505	562	779	<input type="checkbox"/>	<input type="checkbox"/>	<input type="checkbox"/>	<input type="checkbox"/>
22 36	MOD8SBR2236	<input type="checkbox"/>	<input type="checkbox"/>	505	562	776	<input type="checkbox"/>	<input type="checkbox"/>	<input type="checkbox"/>	<input type="checkbox"/>
22 42	MOD8SBR2242	<input type="checkbox"/>	<input type="checkbox"/>	528	585	799	<input type="checkbox"/>	<input type="checkbox"/>	<input type="checkbox"/>	<input type="checkbox"/>
22 48	MOD8SBR2248	<input type="checkbox"/>	<input type="checkbox"/>	560	616	830	<input type="checkbox"/>	<input type="checkbox"/>	<input type="checkbox"/>	<input type="checkbox"/>
24 30	MOD8SBR2430	<input type="checkbox"/>	<input type="checkbox"/>	505	562	779	<input type="checkbox"/>	<input type="checkbox"/>	<input type="checkbox"/>	<input type="checkbox"/>
24 36	MOD8SBR2436	<input type="checkbox"/>	<input type="checkbox"/>	505	562	776	<input type="checkbox"/>	<input type="checkbox"/>	<input type="checkbox"/>	<input type="checkbox"/>
24 42	MOD8SBR2442	<input type="checkbox"/>	<input type="checkbox"/>	528	585	799	<input type="checkbox"/>	<input type="checkbox"/>	<input type="checkbox"/>	<input type="checkbox"/>
24 48	MOD8SBR2448	<input type="checkbox"/>	<input type="checkbox"/>	560	616	830	<input type="checkbox"/>	<input type="checkbox"/>	<input type="checkbox"/>	<input type="checkbox"/>
30 30	MOD8SBR3030	<input type="checkbox"/>	<input type="checkbox"/>	534	591	804	<input type="checkbox"/>	<input type="checkbox"/>	<input type="checkbox"/>	<input type="checkbox"/>
30 36	MOD8SBR3036	<input type="checkbox"/>	<input type="checkbox"/>	534	591	804	<input type="checkbox"/>	<input type="checkbox"/>	<input type="checkbox"/>	<input type="checkbox"/>
30 42	MOD8SBR3042	<input type="checkbox"/>	<input type="checkbox"/>	560	616	830	<input type="checkbox"/>	<input type="checkbox"/>	<input type="checkbox"/>	<input type="checkbox"/>
30 48	MOD8SBR3048	<input type="checkbox"/>	<input type="checkbox"/>	587	644	858	<input type="checkbox"/>	<input type="checkbox"/>	<input type="checkbox"/>	<input type="checkbox"/>

BRIDGE

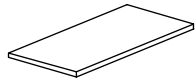

RESOURCES

SHELL DESKS	05
STORAGE SUPPORTED	17
OVERHEAD STORAGE	37
STORAGE TOWERS	51
ACCESSORIES	65
FINISHES	76

OPTIONS

Grain Direction

Surface grain direction can be specified front-to-back "F" or side-to-side "S".

Modesty Panel ships standard with horizontal grain direction. Vertical grain option available, contact customer service to order.

Optional Edge Inlay

A chrome or black edge inlay is available with Detailed edge options. Contact customer service for ordering information.

Grommets

To add factory installed grommets place a "G" after the edge profile code above and add \$56 list for each desk.

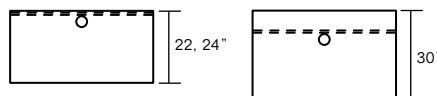
Grommet & Modesty Location

EDGES

Edge Profile		Edge Code
WoodPlus & 3mm		
	Smooth	S
	Reeded	R
	NeoClassic	E
Detailed		
	Radius	D
	Beveled	B
	Transitional	T
	Reeded	R
	Classic	C

For a closer look at edge styles, visit our website.

EXTENSIONS

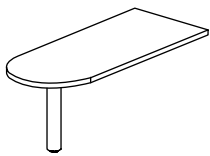

BULLET
Single Column Base

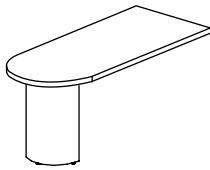

BULLET
Half Cylinder Base

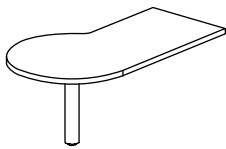

P-TOP
Single Column Base
Right Hand Shown

A / B

30 60
30 66
30 72
36 60
36 66
36 72

30 60
30 66
30 72
36 60
36 66
36 72

42 72
42 78
42 84

PRODUCT		EDGE					FINISHES				
A	B	Product Code	Left = L Right = R	Wood Plus	3mm	Detailed	Edge Profile <i>See Below</i>	Surface	Edge	Base Powder	Half Cylinder
				P	W	D					
				\$	\$	\$					
		MOD8EBU3060S	-	1105	1425	1694	<input type="checkbox"/>	<input type="checkbox"/>	<input type="checkbox"/>	<input type="checkbox"/>	-
		MOD8EBU3066S	-	1207	1527	1797	<input type="checkbox"/>	<input type="checkbox"/>	<input type="checkbox"/>	<input type="checkbox"/>	-
		MOD8EBU3072S	-	1249	1569	1838	<input type="checkbox"/>	<input type="checkbox"/>	<input type="checkbox"/>	<input type="checkbox"/>	-
		MOD8EBU3660S	-	1249	1569	1838	<input type="checkbox"/>	<input type="checkbox"/>	<input type="checkbox"/>	<input type="checkbox"/>	-
		MOD8EBU3666S	-	1307	1627	1896	<input type="checkbox"/>	<input type="checkbox"/>	<input type="checkbox"/>	<input type="checkbox"/>	-
		MOD8EBU3672S	-	1354	1674	1943	<input type="checkbox"/>	<input type="checkbox"/>	<input type="checkbox"/>	<input type="checkbox"/>	-
		MOD8EBU3060H	-	1604	1907	2175	<input type="checkbox"/>	<input type="checkbox"/>	<input type="checkbox"/>	-	<input type="checkbox"/>
		MOD8EBU3066H	-	1710	2014	2282	<input type="checkbox"/>	<input type="checkbox"/>	<input type="checkbox"/>	-	<input type="checkbox"/>
		MOD8EBU3072H	-	1757	2061	2329	<input type="checkbox"/>	<input type="checkbox"/>	<input type="checkbox"/>	-	<input type="checkbox"/>
		MOD8EBU3660H	-	1797	2100	2368	<input type="checkbox"/>	<input type="checkbox"/>	<input type="checkbox"/>	-	<input type="checkbox"/>
		MOD8EBU3666H	-	1852	2156	2424	<input type="checkbox"/>	<input type="checkbox"/>	<input type="checkbox"/>	-	<input type="checkbox"/>
		MOD8EBU3672H	-	1900	2204	2472	<input type="checkbox"/>	<input type="checkbox"/>	<input type="checkbox"/>	-	<input type="checkbox"/>
		MOD8EPT4272S	<input type="checkbox"/>	1853	2274	2637	<input type="checkbox"/>	<input type="checkbox"/>	<input type="checkbox"/>	<input type="checkbox"/>	-
		MOD8EPT4278S	<input type="checkbox"/>	1920	2342	2742	<input type="checkbox"/>	<input type="checkbox"/>	<input type="checkbox"/>	<input type="checkbox"/>	-
		MOD8EPT4284S	<input type="checkbox"/>	1920	2342	2742	<input type="checkbox"/>	<input type="checkbox"/>	<input type="checkbox"/>	<input type="checkbox"/>	-

RESOURCES

SHELL DESKS	05
STORAGE SUPPORTED	17
OVERHEAD STORAGE	37
STORAGE TOWERS	51
ACCESSORIES	65
FINISHES	76

Extensions ship with required mounting hardware to attach Extensions to other surfaces.

Bullet surface with a Half Cylinder base and 30 inch deep radius extension ships with a 18 inch diameter base.

Bullet surface with a Half Cylinder base 36 inch deep radius extension ships with a 24 inch diameter base.

OPTIONS

Grain Direction

Surface grain direction runs the length of the work-surface.

Optional Edge Inlay

A chrome or black edge inlay is available with Detailed edge options. Contact customer service for ordering information.

Grommets

To add factory installed grommets place a "G" after the edge profile code above and add \$56 list for each desk.

Extension Details

Dimension information and optional grommet locations are shown below.

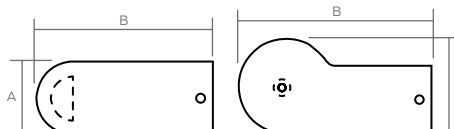

EDGES

Edge Profile **Edge Code**

WoodPlus & 3mm



	Smooth	S
	Reeded	R
	NeoClassic	E

Detailed

	Radius	D
	Beveled	B
	Transitional	T
	Reeded	R
	Classic	C

For a closer look at edge styles, visit our website.

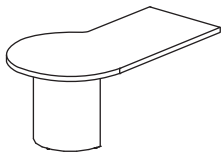
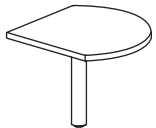
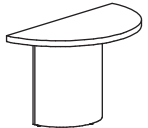
EXTENSIONS

A / B		PRODUCT	Left=L Right=R	Wood Plus P	3mm W	Detailed D	Edge Profile See Below	Surface	Edge	Base Panels	Base Powder	Half Cylinder
 <p>P-TOP Half Cylinder Base Right Hand Shown</p>	42 72	MOD8EPT4272H	<input type="checkbox"/>	2231	2679	3044	<input type="checkbox"/>	<input type="checkbox"/>	<input type="checkbox"/>	-	-	<input type="checkbox"/>
	42 78	MOD8EPT4278H	<input type="checkbox"/>	2295	2746	3144	<input type="checkbox"/>	<input type="checkbox"/>	<input type="checkbox"/>	-	-	<input type="checkbox"/>
	42 84	MOD8EPT4284H	<input type="checkbox"/>	2295	2746	3144	<input type="checkbox"/>	<input type="checkbox"/>	<input type="checkbox"/>	-	-	<input type="checkbox"/>
 <p>TEAR DROP Single Column Base</p>	42 30	MOD8ETD4230S	-	914	1222	1382	<input type="checkbox"/>	<input type="checkbox"/>	<input type="checkbox"/>	-	<input type="checkbox"/>	-
	51 36	MOD8ETD5136S	-	1138	1447	1606	<input type="checkbox"/>	<input type="checkbox"/>	<input type="checkbox"/>	-	<input type="checkbox"/>	-
 <p>HALF ROUND Half Cylinder Base</p>	24 48	MOD8EHR2448H	-	913	1221	1381	<input type="checkbox"/>	<input type="checkbox"/>	<input type="checkbox"/>	-	-	<input type="checkbox"/>
	30 60	MOD8EHR3060H	-	1005	1325	1594	<input type="checkbox"/>	<input type="checkbox"/>	<input type="checkbox"/>	-	-	<input type="checkbox"/>
 <p>QUARTER ROUND</p>	24 24	MOD8EQR2424	<input type="checkbox"/>	1254	1414	1799	<input type="checkbox"/>	<input type="checkbox"/>	<input type="checkbox"/>	-	-	-
	30 30	MOD8EQR3030	<input type="checkbox"/>	1418	1578	1963	<input type="checkbox"/>	<input type="checkbox"/>	<input type="checkbox"/>	-	-	-

RESOURCES

SHELL DESKS	05
STORAGE SUPPORTED	17
OVERHEAD STORAGE	37
STORAGE TOWERS	51
ACCESSORIES	65
FINISHES	76

Extensions ship with required mounting hardware to attach Extensions to other surfaces.

P-Top surface ships with a 24 inch diameter base.

Half Round must be attached to wall or another desk, brackets are included.

Quarter Round shelf finish matches base laminate finish.

OPTIONS

Grain Direction

Surface grain direction runs the length of the work-surface.

Quarter Round grain direction is based on the hand (Left or Right) specified.

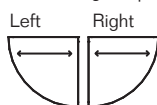

Optional Edge Inlay

A chrome or black edge inlay is available with Detailed edge options. Contact customer service for ordering information.

Grommets (P-Top Only)







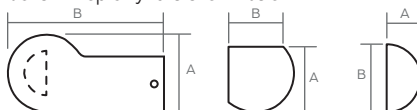

To add factory installed grommets place a "G" after the edge profile code above and add \$56 list for each desk.

Extension Details

Dimension information and optional grommet locations (P-Top only) are shown below.



EDGES

Edge Profile		Edge Code
WoodPlus & 3mm		
	Smooth	S
	Reeded	R
	NeoClassic	E
Detailed		
	Radius	D
	Beveled	B
	Transitional	T
	Reeded	R
	Classic	C

For a closer look at edge styles, visit our website.

NOTES

For Customer Service Inquiries, please contact:

800.426.1202

360.394.1322 *fax*

www.magnadesign.com

OVERHEAD STORAGE

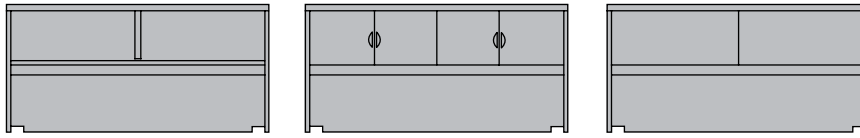

Hutches

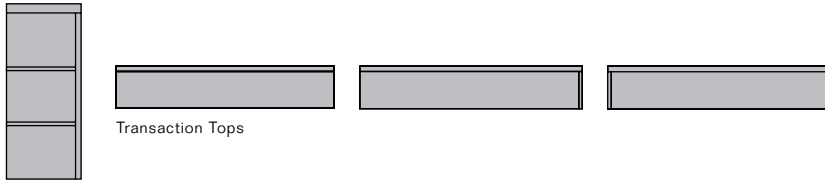

Transaction Tops

Quarter Round

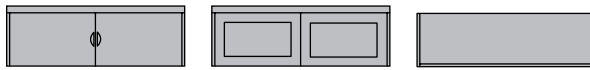

Wall Mounted

OVERHEAD STORAGE

How To	38
Hutch	39
Quarter Round	47
Transaction Top	47
Wall Mount Storage	49

HOW TO

SPECIFY A HUTCH FOR A MOD EIGHT WORKSTATION**Be sure your workstation can support a Hutch.**

All Hutchers need support directly below each end. Support can be achieved with Storage components (p. 23-27) or End Panels (p.27).

End Panel Support:

End Panel must be located directly below the Hutch end panel.

Panel must be full surface depth.

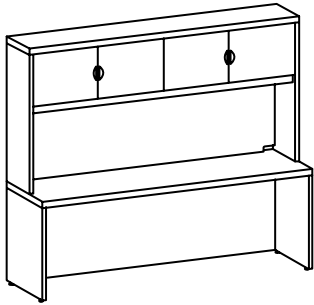

Full Surface Coverage

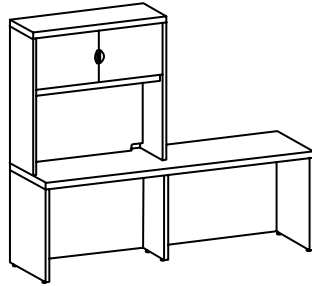

Half Surface Coverage (Additional End Panel Required)

Storage Support:

Storage must be located directly below the Hutch end panel.

Storage must be full surface depth.

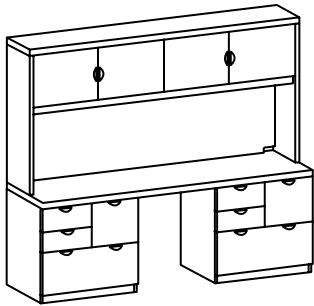

Full Storage Support

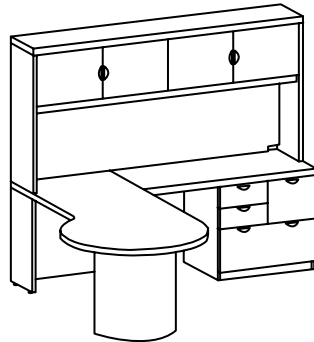

Storage + End Panel Support

Do NOT Specify:

36-inch deep Rectangles are not sufficient for Hutch support.

Worksurface overhangs the end panel, therefore cannot be used for Hutch support.

(Below image shown as storage support configuration)

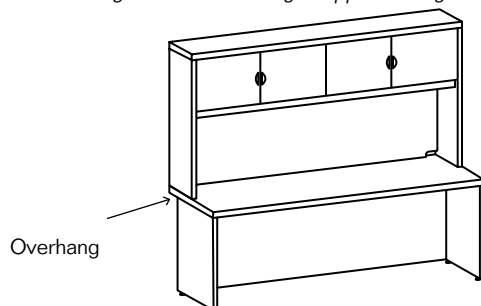

Overhang

HUTCH

PRODUCT

EDGE

FINISHES

H / W

Wood
Plus

3mm

Detailed

Edge
Profile

Surface

Edge

Case

P

W

D

See
Below

\$

\$

\$

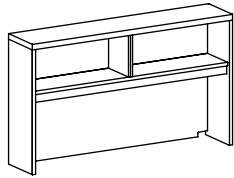

OPEN

35	36	MOD8HOP3536N	1098	1258	1421	<input type="checkbox"/>	<input type="checkbox"/>	<input type="checkbox"/>	<input type="checkbox"/>
35	42	MOD8HOP3542N	1196	1356	1519	<input type="checkbox"/>	<input type="checkbox"/>	<input type="checkbox"/>	<input type="checkbox"/>
35	48	MOD8HOP3548N	1196	1356	1519	<input type="checkbox"/>	<input type="checkbox"/>	<input type="checkbox"/>	<input type="checkbox"/>
35	54	MOD8HOP3554N	1375	1535	1698	<input type="checkbox"/>	<input type="checkbox"/>	<input type="checkbox"/>	<input type="checkbox"/>
35	60	MOD8HOP3560N	1375	1535	1698	<input type="checkbox"/>	<input type="checkbox"/>	<input type="checkbox"/>	<input type="checkbox"/>
35	66	MOD8HOP3566N	1495	1656	1818	<input type="checkbox"/>	<input type="checkbox"/>	<input type="checkbox"/>	<input type="checkbox"/>
35	72	MOD8HOP3572N	1495	1656	1818	<input type="checkbox"/>	<input type="checkbox"/>	<input type="checkbox"/>	<input type="checkbox"/>
35	78	MOD8HOP3578N	1594	1755	1934	<input type="checkbox"/>	<input type="checkbox"/>	<input type="checkbox"/>	<input type="checkbox"/>
35	84	MOD8HOP3584N	1594	1755	1934	<input type="checkbox"/>	<input type="checkbox"/>	<input type="checkbox"/>	<input type="checkbox"/>
35	90	MOD8HOP3590N	1927	2088	2267	<input type="checkbox"/>	<input type="checkbox"/>	<input type="checkbox"/>	<input type="checkbox"/>
35	96	MOD8HOP3596N	1927	2088	2267	<input type="checkbox"/>	<input type="checkbox"/>	<input type="checkbox"/>	<input type="checkbox"/>
35	102	MOD8HOP35102N	2113	2274	2471	<input type="checkbox"/>	<input type="checkbox"/>	<input type="checkbox"/>	<input type="checkbox"/>
35	108	MOD8HOP35108N	2113	2274	2471	<input type="checkbox"/>	<input type="checkbox"/>	<input type="checkbox"/>	<input type="checkbox"/>
35	114	MOD8HOP35114N	2219	2380	2577	<input type="checkbox"/>	<input type="checkbox"/>	<input type="checkbox"/>	<input type="checkbox"/>
35	120	MOD8HOP35120N	2219	2380	2577	<input type="checkbox"/>	<input type="checkbox"/>	<input type="checkbox"/>	<input type="checkbox"/>
42	36	MOD8HOP4236N	1149	1309	1472	<input type="checkbox"/>	<input type="checkbox"/>	<input type="checkbox"/>	<input type="checkbox"/>
42	42	MOD8HOP4242N	1248	1408	1571	<input type="checkbox"/>	<input type="checkbox"/>	<input type="checkbox"/>	<input type="checkbox"/>
42	48	MOD8HOP4248N	1248	1408	1571	<input type="checkbox"/>	<input type="checkbox"/>	<input type="checkbox"/>	<input type="checkbox"/>
42	54	MOD8HOP4254N	1427	1587	1750	<input type="checkbox"/>	<input type="checkbox"/>	<input type="checkbox"/>	<input type="checkbox"/>
42	60	MOD8HOP4260N	1427	1587	1750	<input type="checkbox"/>	<input type="checkbox"/>	<input type="checkbox"/>	<input type="checkbox"/>
42	66	MOD8HOP4266N	1545	1705	1868	<input type="checkbox"/>	<input type="checkbox"/>	<input type="checkbox"/>	<input type="checkbox"/>
42	72	MOD8HOP4272N	1545	1705	1868	<input type="checkbox"/>	<input type="checkbox"/>	<input type="checkbox"/>	<input type="checkbox"/>
42	78	MOD8HOP4278N	1689	1850	2029	<input type="checkbox"/>	<input type="checkbox"/>	<input type="checkbox"/>	<input type="checkbox"/>
42	84	MOD8HOP4284N	1689	1850	2029	<input type="checkbox"/>	<input type="checkbox"/>	<input type="checkbox"/>	<input type="checkbox"/>
42	90	MOD8HOP4290N	2022	2182	2361	<input type="checkbox"/>	<input type="checkbox"/>	<input type="checkbox"/>	<input type="checkbox"/>
42	96	MOD8HOP4296N	2022	2182	2361	<input type="checkbox"/>	<input type="checkbox"/>	<input type="checkbox"/>	<input type="checkbox"/>
54	36	MOD8HOP5436N	1704	1865	2028	<input type="checkbox"/>	<input type="checkbox"/>	<input type="checkbox"/>	<input type="checkbox"/>
54	42	MOD8HOP5442N	1855	2016	2179	<input type="checkbox"/>	<input type="checkbox"/>	<input type="checkbox"/>	<input type="checkbox"/>
54	48	MOD8HOP5448N	1855	2016	2179	<input type="checkbox"/>	<input type="checkbox"/>	<input type="checkbox"/>	<input type="checkbox"/>
54	54	MOD8HOP5454N	2134	2294	2457	<input type="checkbox"/>	<input type="checkbox"/>	<input type="checkbox"/>	<input type="checkbox"/>
54	60	MOD8HOP5460N	2134	2294	2457	<input type="checkbox"/>	<input type="checkbox"/>	<input type="checkbox"/>	<input type="checkbox"/>
54	66	MOD8HOP5466N	2315	2476	2639	<input type="checkbox"/>	<input type="checkbox"/>	<input type="checkbox"/>	<input type="checkbox"/>
54	72	MOD8HOP5472N	2315	2476	2639	<input type="checkbox"/>	<input type="checkbox"/>	<input type="checkbox"/>	<input type="checkbox"/>
54	78	MOD8HOP5478N	2607	2768	2947	<input type="checkbox"/>	<input type="checkbox"/>	<input type="checkbox"/>	<input type="checkbox"/>
54	84	MOD8HOP5484N	2607	2768	2947	<input type="checkbox"/>	<input type="checkbox"/>	<input type="checkbox"/>	<input type="checkbox"/>
54	90	MOD8HOP5490N	2969	3129	3308	<input type="checkbox"/>	<input type="checkbox"/>	<input type="checkbox"/>	<input type="checkbox"/>
54	96	MOD8HOP5496N	2969	3129	3308	<input type="checkbox"/>	<input type="checkbox"/>	<input type="checkbox"/>	<input type="checkbox"/>

RESOURCES

HUTCH ACCESSORIES	66
FINISHES	76

35 inch high Hutch aligns with 65 inch high Storage Towers.

42 inch high Hutch aligns with 72 inch high Storage Towers.

54 inch high Hutch aligns with 84 inch high Storage Towers.

42 and 54 inch high Hutch over 72 inches long must be attached to a wall or to the back of another Hutch.

Hutches must be supported with an undersurface panel directly below each end (Modesty Panel okay).

Hutches ship fully assembled.

EDGES

Edge Profile		Edge Code
WoodPlus & 3mm		
	Smooth	S
	Reeded	R
	NeoClassic	E
Detailed		
	Radius	D
	Beveled	B
	Transitional	T
	Reeded	R
	Classic	C

For a closer look at edge styles, visit our website.

HUTCH

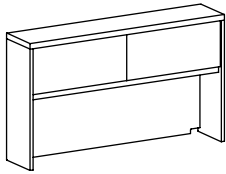

FLIPPER

H / W

H / W		PRODUCT	EDGE				LOCK	FINISHES			
P	W		Wood Plus	3mm	Detailed	Edge Profile	Lock=L Alike=U	Surface	Edge	Case	Face
			\$	\$	\$	See Below	See Below				
35	36	MOD8HFD3536N	1391	1552	1715	<input type="checkbox"/>	<input type="checkbox"/>	<input type="checkbox"/>	<input type="checkbox"/>	<input type="checkbox"/>	<input type="checkbox"/>
35	42	MOD8HFD3542N	1495	1656	1818	<input type="checkbox"/>	<input type="checkbox"/>	<input type="checkbox"/>	<input type="checkbox"/>	<input type="checkbox"/>	<input type="checkbox"/>
35	48	MOD8HFD3548N	1495	1656	1818	<input type="checkbox"/>	<input type="checkbox"/>	<input type="checkbox"/>	<input type="checkbox"/>	<input type="checkbox"/>	<input type="checkbox"/>
35	54	MOD8HFD3554N	1918	2078	2241	<input type="checkbox"/>	<input type="checkbox"/>	<input type="checkbox"/>	<input type="checkbox"/>	<input type="checkbox"/>	<input type="checkbox"/>
35	60	MOD8HFD3560N	1918	2078	2241	<input type="checkbox"/>	<input type="checkbox"/>	<input type="checkbox"/>	<input type="checkbox"/>	<input type="checkbox"/>	<input type="checkbox"/>
35	66	MOD8HFD3566N	2043	2203	2366	<input type="checkbox"/>	<input type="checkbox"/>	<input type="checkbox"/>	<input type="checkbox"/>	<input type="checkbox"/>	<input type="checkbox"/>
35	72	MOD8HFD3572N	2043	2203	2366	<input type="checkbox"/>	<input type="checkbox"/>	<input type="checkbox"/>	<input type="checkbox"/>	<input type="checkbox"/>	<input type="checkbox"/>
35	78	MOD8HFD3578N	2148	2308	2487	<input type="checkbox"/>	<input type="checkbox"/>	<input type="checkbox"/>	<input type="checkbox"/>	<input type="checkbox"/>	<input type="checkbox"/>
35	84	MOD8HFD3584N	2148	2308	2487	<input type="checkbox"/>	<input type="checkbox"/>	<input type="checkbox"/>	<input type="checkbox"/>	<input type="checkbox"/>	<input type="checkbox"/>
35	90	MOD8HFD3590N	2628	2789	2968	<input type="checkbox"/>	<input type="checkbox"/>	<input type="checkbox"/>	<input type="checkbox"/>	<input type="checkbox"/>	<input type="checkbox"/>
35	96	MOD8HFD3596N	2628	2789	2968	<input type="checkbox"/>	<input type="checkbox"/>	<input type="checkbox"/>	<input type="checkbox"/>	<input type="checkbox"/>	<input type="checkbox"/>
42	36	MOD8HFD4236N	1444	1605	1768	<input type="checkbox"/>	<input type="checkbox"/>	<input type="checkbox"/>	<input type="checkbox"/>	<input type="checkbox"/>	<input type="checkbox"/>
42	42	MOD8HFD4242N	1547	1708	1870	<input type="checkbox"/>	<input type="checkbox"/>	<input type="checkbox"/>	<input type="checkbox"/>	<input type="checkbox"/>	<input type="checkbox"/>
42	48	MOD8HFD4248N	1547	1708	1870	<input type="checkbox"/>	<input type="checkbox"/>	<input type="checkbox"/>	<input type="checkbox"/>	<input type="checkbox"/>	<input type="checkbox"/>
42	54	MOD8HFD4254N	1973	2134	2297	<input type="checkbox"/>	<input type="checkbox"/>	<input type="checkbox"/>	<input type="checkbox"/>	<input type="checkbox"/>	<input type="checkbox"/>
42	60	MOD8HFD4260N	1973	2134	2297	<input type="checkbox"/>	<input type="checkbox"/>	<input type="checkbox"/>	<input type="checkbox"/>	<input type="checkbox"/>	<input type="checkbox"/>
42	66	MOD8HFD4266N	2096	2256	2419	<input type="checkbox"/>	<input type="checkbox"/>	<input type="checkbox"/>	<input type="checkbox"/>	<input type="checkbox"/>	<input type="checkbox"/>
42	72	MOD8HFD4272N	2096	2256	2419	<input type="checkbox"/>	<input type="checkbox"/>	<input type="checkbox"/>	<input type="checkbox"/>	<input type="checkbox"/>	<input type="checkbox"/>
42	78	MOD8HFD4278N	2242	2403	2566	<input type="checkbox"/>	<input type="checkbox"/>	<input type="checkbox"/>	<input type="checkbox"/>	<input type="checkbox"/>	<input type="checkbox"/>
42	84	MOD8HFD4284N	2242	2403	2566	<input type="checkbox"/>	<input type="checkbox"/>	<input type="checkbox"/>	<input type="checkbox"/>	<input type="checkbox"/>	<input type="checkbox"/>
42	90	MOD8HFD4290N	2724	2885	3047	<input type="checkbox"/>	<input type="checkbox"/>	<input type="checkbox"/>	<input type="checkbox"/>	<input type="checkbox"/>	<input type="checkbox"/>
42	96	MOD8HFD4296N	2724	2885	3047	<input type="checkbox"/>	<input type="checkbox"/>	<input type="checkbox"/>	<input type="checkbox"/>	<input type="checkbox"/>	<input type="checkbox"/>

RESOURCES

HUTCH ACCESSORIES

66

FINISHES

76

35 inch high Hutch aligns with 65 inch high Storage Towers. 42 inch high Hutch aligns with 72 inch high Storage Towers.

42 inch high Hutch over 72 inches long must be attached to a wall or to the back of another Hutch.

Hutches must be supported with an undersurface panel directly below each end (Modesty Panel okay).

Hutches ship fully assembled.

EDGES

Edge Profile

Edge Code

WoodPlus & 3mm



Smooth

S

Reeded

R

NeoClassic

E

Detailed



Radius

D

Beveled

B

Transitional

T

Reeded

R

Classic

C

For a closer look at edge styles, visit our website.

HUTCH

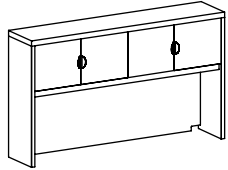

WOOD DOOR

H / W

35	36
35	42
35	48
35	54
35	60
35	66
35	72
35	78
35	84
35	90
35	96
35	102
35	108
35	114
35	120
42	36
42	42
42	48
42	54
42	60
42	66
42	72
42	78
42	84
42	90
42	96
54	36
54	42
54	48
54	54
54	60
54	66
54	72
54	78
54	84
54	90
54	96

PRODUCT	EDGE				OPTIONS			FINISHES			
	Wood Plus	3mm	Detailed	Edge Profile	Lock=L Alike=U	Pull	Surface	Edge	Case	Face	
	P	W	D	See Below	See Below	See Below					
	\$	\$	\$								
MOD8HWD3536N	1391	1552	1715	<input type="checkbox"/>	<input type="checkbox"/>	<input type="checkbox"/>	<input type="checkbox"/>	<input type="checkbox"/>	<input type="checkbox"/>	<input type="checkbox"/>	
MOD8HWD3542N	1495	1656	1818	<input type="checkbox"/>	<input type="checkbox"/>	<input type="checkbox"/>	<input type="checkbox"/>	<input type="checkbox"/>	<input type="checkbox"/>	<input type="checkbox"/>	
MOD8HWD3548N	1495	1656	1818	<input type="checkbox"/>	<input type="checkbox"/>	<input type="checkbox"/>	<input type="checkbox"/>	<input type="checkbox"/>	<input type="checkbox"/>	<input type="checkbox"/>	
MOD8HWD3554N	1918	2078	2241	<input type="checkbox"/>	<input type="checkbox"/>	<input type="checkbox"/>	<input type="checkbox"/>	<input type="checkbox"/>	<input type="checkbox"/>	<input type="checkbox"/>	
MOD8HWD3560N	1918	2078	2241	<input type="checkbox"/>	<input type="checkbox"/>	<input type="checkbox"/>	<input type="checkbox"/>	<input type="checkbox"/>	<input type="checkbox"/>	<input type="checkbox"/>	
MOD8HWD3566N	2043	2203	2366	<input type="checkbox"/>	<input type="checkbox"/>	<input type="checkbox"/>	<input type="checkbox"/>	<input type="checkbox"/>	<input type="checkbox"/>	<input type="checkbox"/>	
MOD8HWD3572N	2043	2203	2366	<input type="checkbox"/>	<input type="checkbox"/>	<input type="checkbox"/>	<input type="checkbox"/>	<input type="checkbox"/>	<input type="checkbox"/>	<input type="checkbox"/>	
MOD8HWD3578N	2148	2308	2487	<input type="checkbox"/>	<input type="checkbox"/>	<input type="checkbox"/>	<input type="checkbox"/>	<input type="checkbox"/>	<input type="checkbox"/>	<input type="checkbox"/>	
MOD8HWD3584N	2148	2308	2487	<input type="checkbox"/>	<input type="checkbox"/>	<input type="checkbox"/>	<input type="checkbox"/>	<input type="checkbox"/>	<input type="checkbox"/>	<input type="checkbox"/>	
MOD8HWD3590N	2628	2789	2968	<input type="checkbox"/>	<input type="checkbox"/>	<input type="checkbox"/>	<input type="checkbox"/>	<input type="checkbox"/>	<input type="checkbox"/>	<input type="checkbox"/>	
MOD8HWD3596N	2628	2789	2968	<input type="checkbox"/>	<input type="checkbox"/>	<input type="checkbox"/>	<input type="checkbox"/>	<input type="checkbox"/>	<input type="checkbox"/>	<input type="checkbox"/>	
MOD8HWD35102N	3280	3440	3638	<input type="checkbox"/>	<input type="checkbox"/>	<input type="checkbox"/>	<input type="checkbox"/>	<input type="checkbox"/>	<input type="checkbox"/>	<input type="checkbox"/>	
MOD8HWD35108N	3280	3440	3638	<input type="checkbox"/>	<input type="checkbox"/>	<input type="checkbox"/>	<input type="checkbox"/>	<input type="checkbox"/>	<input type="checkbox"/>	<input type="checkbox"/>	
MOD8HWD35114N	3415	3575	3773	<input type="checkbox"/>	<input type="checkbox"/>	<input type="checkbox"/>	<input type="checkbox"/>	<input type="checkbox"/>	<input type="checkbox"/>	<input type="checkbox"/>	
MOD8HWD35120N	3415	3575	3773	<input type="checkbox"/>	<input type="checkbox"/>	<input type="checkbox"/>	<input type="checkbox"/>	<input type="checkbox"/>	<input type="checkbox"/>	<input type="checkbox"/>	
MOD8HWD4236N	1444	1605	1768	<input type="checkbox"/>	<input type="checkbox"/>	<input type="checkbox"/>	<input type="checkbox"/>	<input type="checkbox"/>	<input type="checkbox"/>	<input type="checkbox"/>	
MOD8HWD4242N	1547	1708	1870	<input type="checkbox"/>	<input type="checkbox"/>	<input type="checkbox"/>	<input type="checkbox"/>	<input type="checkbox"/>	<input type="checkbox"/>	<input type="checkbox"/>	
MOD8HWD4248N	1547	1708	1870	<input type="checkbox"/>	<input type="checkbox"/>	<input type="checkbox"/>	<input type="checkbox"/>	<input type="checkbox"/>	<input type="checkbox"/>	<input type="checkbox"/>	
MOD8HWD4254N	1973	2134	2297	<input type="checkbox"/>	<input type="checkbox"/>	<input type="checkbox"/>	<input type="checkbox"/>	<input type="checkbox"/>	<input type="checkbox"/>	<input type="checkbox"/>	
MOD8HWD4260N	1973	2134	2297	<input type="checkbox"/>	<input type="checkbox"/>	<input type="checkbox"/>	<input type="checkbox"/>	<input type="checkbox"/>	<input type="checkbox"/>	<input type="checkbox"/>	
MOD8HWD4266N	2096	2256	2419	<input type="checkbox"/>	<input type="checkbox"/>	<input type="checkbox"/>	<input type="checkbox"/>	<input type="checkbox"/>	<input type="checkbox"/>	<input type="checkbox"/>	
MOD8HWD4272N	2096	2256	2419	<input type="checkbox"/>	<input type="checkbox"/>	<input type="checkbox"/>	<input type="checkbox"/>	<input type="checkbox"/>	<input type="checkbox"/>	<input type="checkbox"/>	
MOD8HWD4278N	2242	2403	2582	<input type="checkbox"/>	<input type="checkbox"/>	<input type="checkbox"/>	<input type="checkbox"/>	<input type="checkbox"/>	<input type="checkbox"/>	<input type="checkbox"/>	
MOD8HWD4284N	2242	2403	2582	<input type="checkbox"/>	<input type="checkbox"/>	<input type="checkbox"/>	<input type="checkbox"/>	<input type="checkbox"/>	<input type="checkbox"/>	<input type="checkbox"/>	
MOD8HWD4290N	2724	2885	3064	<input type="checkbox"/>	<input type="checkbox"/>	<input type="checkbox"/>	<input type="checkbox"/>	<input type="checkbox"/>	<input type="checkbox"/>	<input type="checkbox"/>	
MOD8HWD4296N	2724	2885	3064	<input type="checkbox"/>	<input type="checkbox"/>	<input type="checkbox"/>	<input type="checkbox"/>	<input type="checkbox"/>	<input type="checkbox"/>	<input type="checkbox"/>	
MOD8HWD5436N	2144	2305	2468	<input type="checkbox"/>	<input type="checkbox"/>	<input type="checkbox"/>	<input type="checkbox"/>	<input type="checkbox"/>	<input type="checkbox"/>	<input type="checkbox"/>	
MOD8HWD5442N	2302	2463	2626	<input type="checkbox"/>	<input type="checkbox"/>	<input type="checkbox"/>	<input type="checkbox"/>	<input type="checkbox"/>	<input type="checkbox"/>	<input type="checkbox"/>	
MOD8HWD5448N	2302	2463	2626	<input type="checkbox"/>	<input type="checkbox"/>	<input type="checkbox"/>	<input type="checkbox"/>	<input type="checkbox"/>	<input type="checkbox"/>	<input type="checkbox"/>	
MOD8HWD5454N	2949	3110	3273	<input type="checkbox"/>	<input type="checkbox"/>	<input type="checkbox"/>	<input type="checkbox"/>	<input type="checkbox"/>	<input type="checkbox"/>	<input type="checkbox"/>	
MOD8HWD5460N	2949	3110	3273	<input type="checkbox"/>	<input type="checkbox"/>	<input type="checkbox"/>	<input type="checkbox"/>	<input type="checkbox"/>	<input type="checkbox"/>	<input type="checkbox"/>	
MOD8HWD5466N	3135	3296	3459	<input type="checkbox"/>	<input type="checkbox"/>	<input type="checkbox"/>	<input type="checkbox"/>	<input type="checkbox"/>	<input type="checkbox"/>	<input type="checkbox"/>	
MOD8HWD5472N	3135	3296	3459	<input type="checkbox"/>	<input type="checkbox"/>	<input type="checkbox"/>	<input type="checkbox"/>	<input type="checkbox"/>	<input type="checkbox"/>	<input type="checkbox"/>	
MOD8HWD5478N	3299	3460	3639	<input type="checkbox"/>	<input type="checkbox"/>	<input type="checkbox"/>	<input type="checkbox"/>	<input type="checkbox"/>	<input type="checkbox"/>	<input type="checkbox"/>	
MOD8HWD5484N	3299	3460	3639	<input type="checkbox"/>	<input type="checkbox"/>	<input type="checkbox"/>	<input type="checkbox"/>	<input type="checkbox"/>	<input type="checkbox"/>	<input type="checkbox"/>	
MOD8HWD5490N	4021	4182	4361	<input type="checkbox"/>	<input type="checkbox"/>	<input type="checkbox"/>	<input type="checkbox"/>	<input type="checkbox"/>	<input type="checkbox"/>	<input type="checkbox"/>	
MOD8HWD5496N	4021	4182	4361	<input type="checkbox"/>	<input type="checkbox"/>	<input type="checkbox"/>	<input type="checkbox"/>	<input type="checkbox"/>	<input type="checkbox"/>	<input type="checkbox"/>	

RESOURCES

HUTCH ACCESSORIES	66
FINISHES	76

35 inch high Hutch aligns with 65 inch high Storage Towers. 42 inch high Hutch aligns with 72 inch high Storage Towers. 54 inch high Hutch aligns with 84 inch high Storage Towers.

42 and 54 inch high Hutches over 72 inches long must be attached to a wall or to the back of another Hutch.

Hutches must be supported with an undersurface panel directly below each end (Modesty Panel okay).

Hutches ship fully assembled.

PULLS

Pull Style	Pull Color	Pull Code
	Black	12
	Silver	13
	Black	30
	Silver	31
	Touchlatch	NN

Locks

Randomly keyed locks "L" are standard on all storage units. Storage locks can be specified keyed alike "U" if required. Keyed alike option is field installed.

EDGES

Edge Profile	Edge Code
WoodPlus & 3mm	
Smooth	S
Reeded	R
NeoClassic	E
Detailed	
Radius	D
Beveled	B
Transitional	T
Reeded	R
Classic	C

For a closer look at edge styles, visit our website.

HUTCH		PRODUCT	EDGE				FINISHES		
H / W			Wood Plus	3mm	Detailed	Edge Profile	Surface	Edge	Case
		P	W	D	See Below				
			\$	\$	\$				
35	36	MOD8HGD3536N	1897	2058	2220				
35	42	MOD8HGD3542N	2064	2225	2388				
35	48	MOD8HGD3548N	2225	2386	2548				
35	54	MOD8HGD3554N	2846	3007	3170				
35	60	MOD8HGD3560N	2846	3007	3170				
35	66	MOD8HGD3566N	3039	3200	3363				
35	72	MOD8HGD3572N	3109	3269	3432				
35	78	MOD8HGD3578N	3282	3442	3621				
35	84	MOD8HGD3584N	3350	3511	3690				
35	90	MOD8HGD3590N	4029	4190	4369				
35	96	MOD8HGD3596N	4190	4350	4529				
35	102	MOD8HGD36102N	4928	5088	5286				
35	108	MOD8HGD36108N	4997	5158	5355				
35	114	MOD8HGD36114N	5200	5361	5558				
35	120	MOD8HGD36120N	5270	5430	5628				
42	36	MOD8HGD4236N	1950	2111	2274				
42	42	MOD8HGD4242N	2116	2277	2440				
42	48	MOD8HGD4248N	2277	2438	2600				
42	54	MOD8HGD4254N	2901	3061	3224				
42	60	MOD8HGD4260N	2901	3061	3224				
42	66	MOD8HGD4266N	3092	3253	3416				
42	72	MOD8HGD4272N	3163	3323	3486				
42	78	MOD8HGD4278N	3375	3536	3715				
42	84	MOD8HGD4284N	3445	3605	3784				
42	90	MOD8HGD4290N	4124	4284	4463				
42	96	MOD8HGD4296N	4284	4445	4624				
54	36	MOD8HGD5436N	2904	3065	3228				
54	42	MOD8HGD5442N	3157	3318	3481				
54	48	MOD8HGD5448N	3397	3558	3721				
54	54	MOD8HGD5454N	4341	4502	4664				
54	60	MOD8HGD5460N	4341	4502	4664				
54	66	MOD8HGD5466N	4631	4791	4954				
54	72	MOD8HGD5472N	4736	4897	5059				
54	78	MOD8HGD5478N	4999	5160	5339				
54	84	MOD8HGD5484N	5102	5263	5442				
54	90	MOD8HGD5490N	6122	6283	6462				
54	96	MOD8HGD5496N	6362	6523	6702				

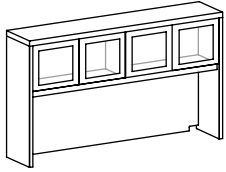

GLASS DOOR

RESOURCES

HUTCH ACCESSORIES

66

FINISHES

76

Glass doors available with touch latch only.

42 inch high Hutch aligns with 72 inch high Storage Towers. 54 inch high Hutch aligns with 84 inch high Storage Towers.

42 and 54 inch high Hutch over 72 inches long must be attached to a wall or to the back of another Hutch.

Hutches must be supported with an undersurface panel directly below each end (Modesty Panel okay).

Hutches ship fully assembled.

EDGES

Edge Profile

Edge Code

WoodPlus & 3mm



Smooth

S

Reeded

R

NeoClassic

E

Detailed



Radius

D

Beveled

B

Transitional

T

Reeded

R

Classic

C

For a closer look at edge styles, visit our website.

HUTCH

PRODUCT

EDGE

FINISHES

H / W

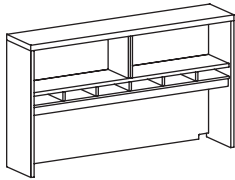

OPEN W/PAPERSHELF

H	W	PRODUCT	Wood Plus	3mm	Detailed	Edge Profile	Surface	Edge	Case
			P	W	D	See Below			
			\$	\$	\$				
42	36	MOD8HOP4236P	1488	1648	1811	<input type="checkbox"/>	<input type="checkbox"/>	<input type="checkbox"/>	<input type="checkbox"/>
42	42	MOD8HOP4242P	1587	1747	1910	<input type="checkbox"/>	<input type="checkbox"/>	<input type="checkbox"/>	<input type="checkbox"/>
42	48	MOD8HOP4248P	1587	1747	1910	<input type="checkbox"/>	<input type="checkbox"/>	<input type="checkbox"/>	<input type="checkbox"/>
42	54	MOD8HOP4254P	1766	1926	2089	<input type="checkbox"/>	<input type="checkbox"/>	<input type="checkbox"/>	<input type="checkbox"/>
42	60	MOD8HOP4260P	1766	1926	2089	<input type="checkbox"/>	<input type="checkbox"/>	<input type="checkbox"/>	<input type="checkbox"/>
42	66	MOD8HOP4266P	1578	2044	2207	<input type="checkbox"/>	<input type="checkbox"/>	<input type="checkbox"/>	<input type="checkbox"/>
42	72	MOD8HOP4272P	1578	2044	2207	<input type="checkbox"/>	<input type="checkbox"/>	<input type="checkbox"/>	<input type="checkbox"/>
42	78	MOD8HOP4278P	2028	2189	2368	<input type="checkbox"/>	<input type="checkbox"/>	<input type="checkbox"/>	<input type="checkbox"/>
42	84	MOD8HOP4284P	2028	2189	2368	<input type="checkbox"/>	<input type="checkbox"/>	<input type="checkbox"/>	<input type="checkbox"/>
42	90	MOD8HOP4290P	2361	2521	2700	<input type="checkbox"/>	<input type="checkbox"/>	<input type="checkbox"/>	<input type="checkbox"/>
42	96	MOD8HOP4296P	2361	2521	2700	<input type="checkbox"/>	<input type="checkbox"/>	<input type="checkbox"/>	<input type="checkbox"/>
54	36	MOD8HOP5436P	2043	2204	2367	<input type="checkbox"/>	<input type="checkbox"/>	<input type="checkbox"/>	<input type="checkbox"/>
54	42	MOD8HOP5442P	2194	2355	2518	<input type="checkbox"/>	<input type="checkbox"/>	<input type="checkbox"/>	<input type="checkbox"/>
54	48	MOD8HOP5448P	2194	2355	2518	<input type="checkbox"/>	<input type="checkbox"/>	<input type="checkbox"/>	<input type="checkbox"/>
54	54	MOD8HOP5454P	2473	2633	2796	<input type="checkbox"/>	<input type="checkbox"/>	<input type="checkbox"/>	<input type="checkbox"/>
54	60	MOD8HOP5460P	2473	2633	2796	<input type="checkbox"/>	<input type="checkbox"/>	<input type="checkbox"/>	<input type="checkbox"/>
54	66	MOD8HOP5466P	2654	2815	2978	<input type="checkbox"/>	<input type="checkbox"/>	<input type="checkbox"/>	<input type="checkbox"/>
54	72	MOD8HOP5472P	2654	2815	2978	<input type="checkbox"/>	<input type="checkbox"/>	<input type="checkbox"/>	<input type="checkbox"/>
54	78	MOD8HOP5478P	2946	3107	3286	<input type="checkbox"/>	<input type="checkbox"/>	<input type="checkbox"/>	<input type="checkbox"/>
54	84	MOD8HOP5484P	2946	3107	3286	<input type="checkbox"/>	<input type="checkbox"/>	<input type="checkbox"/>	<input type="checkbox"/>
54	90	MOD8HOP5490P	3308	3468	3647	<input type="checkbox"/>	<input type="checkbox"/>	<input type="checkbox"/>	<input type="checkbox"/>
54	96	MOD8HOP5496P	3308	3468	3647	<input type="checkbox"/>	<input type="checkbox"/>	<input type="checkbox"/>	<input type="checkbox"/>

RESOURCES

HUTCH ACCESSORIES

66

FINISHES

76

35 inch high Hutch aligns with 65 inch high Storage Towers.

42 inch high Hutch aligns with 72 inch high Storage Towers.

54 inch high Hutch aligns with 84 inch high Storage Towers.

42 and 54 inch high Hutch over 72 inches long must be attached to a wall or to the back of another Hutch.

Hutches must be supported with an undersurface panel directly below each end (Modesty Panel okay).

Hutches ship fully assembled.

EDGES

Edge Profile

Edge Code

WoodPlus & 3mm



Smooth

S

Reeded

R

NeoClassic

E

Detailed



Radius

D

Beveled

B

Transitional

T

Reeded

R

Classic

C

For a closer look at edge styles, visit our website.

HUTCH

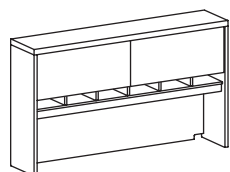

FLIPPER W/PAPERSHELF

H / W

H	W	PRODUCT	EDGE				Lock= L Alike= U	FINISHES			
			Wood Plus	3mm	Detailed	Edge Profile		Surface	Edge	Case	Face
			P	W	D	See Below	See Below				
			\$	\$	\$						
42	36	MOD8HFD4236P	1783	1944	2107	<input type="checkbox"/>	<input type="checkbox"/>	<input type="checkbox"/>	<input type="checkbox"/>	<input type="checkbox"/>	<input type="checkbox"/>
42	42	MOD8HFD4242P	1886	2047	2209	<input type="checkbox"/>	<input type="checkbox"/>	<input type="checkbox"/>	<input type="checkbox"/>	<input type="checkbox"/>	<input type="checkbox"/>
42	48	MOD8HFD4248P	1886	2047	2209	<input type="checkbox"/>	<input type="checkbox"/>	<input type="checkbox"/>	<input type="checkbox"/>	<input type="checkbox"/>	<input type="checkbox"/>
42	54	MOD8HFD4254P	2312	2473	2636	<input type="checkbox"/>	<input type="checkbox"/>	<input type="checkbox"/>	<input type="checkbox"/>	<input type="checkbox"/>	<input type="checkbox"/>
42	60	MOD8HFD4260P	2312	2473	2636	<input type="checkbox"/>	<input type="checkbox"/>	<input type="checkbox"/>	<input type="checkbox"/>	<input type="checkbox"/>	<input type="checkbox"/>
42	66	MOD8HFD4266P	2435	2595	2758	<input type="checkbox"/>	<input type="checkbox"/>	<input type="checkbox"/>	<input type="checkbox"/>	<input type="checkbox"/>	<input type="checkbox"/>
42	72	MOD8HFD4272P	2435	2595	2758	<input type="checkbox"/>	<input type="checkbox"/>	<input type="checkbox"/>	<input type="checkbox"/>	<input type="checkbox"/>	<input type="checkbox"/>
42	78	MOD8HFD4278P	2581	2742	2905	<input type="checkbox"/>	<input type="checkbox"/>	<input type="checkbox"/>	<input type="checkbox"/>	<input type="checkbox"/>	<input type="checkbox"/>
42	84	MOD8HFD4284P	2581	2742	2905	<input type="checkbox"/>	<input type="checkbox"/>	<input type="checkbox"/>	<input type="checkbox"/>	<input type="checkbox"/>	<input type="checkbox"/>
42	90	MOD8HFD4290P	3063	3224	3386	<input type="checkbox"/>	<input type="checkbox"/>	<input type="checkbox"/>	<input type="checkbox"/>	<input type="checkbox"/>	<input type="checkbox"/>
42	96	MOD8HFD4296P	3063	3224	3386	<input type="checkbox"/>	<input type="checkbox"/>	<input type="checkbox"/>	<input type="checkbox"/>	<input type="checkbox"/>	<input type="checkbox"/>

RESOURCES

HUTCH ACCESSORIES

66

FINISHES

76

35 inch high Hutch aligns with 65 inch high Storage Towers. 42 inch high Hutch aligns with 72 inch high Storage Towers.

42 inch high Hutches over 72 inches long must be attached to a wall or to the back of another Hutch.

Hutches must be supported with an undersurface panel directly below each end (Modesty Panel okay).

Hutches ship fully assembled.

Locks

Randomly keyed locks "**L**" are standard on all storage units. Storage locks can be specified keyed alike "**U**" if required. Keyed alike option is field installed.

EDGES

Edge Profile

Edge Code

WoodPlus & 3mm



Smooth

S

Reeded

R

NeoClassic

E

Detailed



Radius

D

Beveled

B

Transitional

T

Reeded

R

Classic

C

For a closer look at edge styles, visit our website.

HUTCH

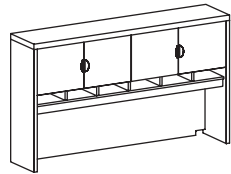

WOOD DOOR W/PAPERSHELF

H / W

H	W	PRODUCT	EDGE				OPTIONS			FINISHES			
			Wood Plus	3mm	Detailed	Edge Profile	Lock=L Alike=U	Pull	Surface	Edge	Case	Face	
			P	W	D	See Below	See Below	See Below					
			\$	\$	\$								
42	36	MOD8HWD4236P	1783	1944	2107	<input type="checkbox"/>	<input type="checkbox"/>	<input type="checkbox"/>	<input type="checkbox"/>	<input type="checkbox"/>	<input type="checkbox"/>	<input type="checkbox"/>	<input type="checkbox"/>
42	42	MOD8HWD4242P	1886	2047	2209	<input type="checkbox"/>	<input type="checkbox"/>	<input type="checkbox"/>	<input type="checkbox"/>	<input type="checkbox"/>	<input type="checkbox"/>	<input type="checkbox"/>	<input type="checkbox"/>
42	48	MOD8HWD4248P	1886	2047	2209	<input type="checkbox"/>	<input type="checkbox"/>	<input type="checkbox"/>	<input type="checkbox"/>	<input type="checkbox"/>	<input type="checkbox"/>	<input type="checkbox"/>	<input type="checkbox"/>
42	54	MOD8HWD4254P	2312	2473	2636	<input type="checkbox"/>	<input type="checkbox"/>	<input type="checkbox"/>	<input type="checkbox"/>	<input type="checkbox"/>	<input type="checkbox"/>	<input type="checkbox"/>	<input type="checkbox"/>
42	60	MOD8HWD4260P	2312	2473	2636	<input type="checkbox"/>	<input type="checkbox"/>	<input type="checkbox"/>	<input type="checkbox"/>	<input type="checkbox"/>	<input type="checkbox"/>	<input type="checkbox"/>	<input type="checkbox"/>
42	66	MOD8HWD4266P	2435	2595	2758	<input type="checkbox"/>	<input type="checkbox"/>	<input type="checkbox"/>	<input type="checkbox"/>	<input type="checkbox"/>	<input type="checkbox"/>	<input type="checkbox"/>	<input type="checkbox"/>
42	72	MOD8HWD4272P	2435	2595	2758	<input type="checkbox"/>	<input type="checkbox"/>	<input type="checkbox"/>	<input type="checkbox"/>	<input type="checkbox"/>	<input type="checkbox"/>	<input type="checkbox"/>	<input type="checkbox"/>
42	78	MOD8HWD4278P	2581	2742	2921	<input type="checkbox"/>	<input type="checkbox"/>	<input type="checkbox"/>	<input type="checkbox"/>	<input type="checkbox"/>	<input type="checkbox"/>	<input type="checkbox"/>	<input type="checkbox"/>
42	84	MOD8HWD4284P	2581	2742	2921	<input type="checkbox"/>	<input type="checkbox"/>	<input type="checkbox"/>	<input type="checkbox"/>	<input type="checkbox"/>	<input type="checkbox"/>	<input type="checkbox"/>	<input type="checkbox"/>
42	90	MOD8HWD4290P	3063	3224	3403	<input type="checkbox"/>	<input type="checkbox"/>	<input type="checkbox"/>	<input type="checkbox"/>	<input type="checkbox"/>	<input type="checkbox"/>	<input type="checkbox"/>	<input type="checkbox"/>
42	96	MOD8HWD4296P	3063	3224	3403	<input type="checkbox"/>	<input type="checkbox"/>	<input type="checkbox"/>	<input type="checkbox"/>	<input type="checkbox"/>	<input type="checkbox"/>	<input type="checkbox"/>	<input type="checkbox"/>
54	36	MOD8HWD5436P	2483	2644	2807	<input type="checkbox"/>	<input type="checkbox"/>	<input type="checkbox"/>	<input type="checkbox"/>	<input type="checkbox"/>	<input type="checkbox"/>	<input type="checkbox"/>	<input type="checkbox"/>
54	42	MOD8HWD5442P	2641	2802	2965	<input type="checkbox"/>	<input type="checkbox"/>	<input type="checkbox"/>	<input type="checkbox"/>	<input type="checkbox"/>	<input type="checkbox"/>	<input type="checkbox"/>	<input type="checkbox"/>
54	48	MOD8HWD5448P	2641	2802	2965	<input type="checkbox"/>	<input type="checkbox"/>	<input type="checkbox"/>	<input type="checkbox"/>	<input type="checkbox"/>	<input type="checkbox"/>	<input type="checkbox"/>	<input type="checkbox"/>
54	54	MOD8HWD5454P	3288	3449	3612	<input type="checkbox"/>	<input type="checkbox"/>	<input type="checkbox"/>	<input type="checkbox"/>	<input type="checkbox"/>	<input type="checkbox"/>	<input type="checkbox"/>	<input type="checkbox"/>
54	60	MOD8HWD5460P	3288	3449	3612	<input type="checkbox"/>	<input type="checkbox"/>	<input type="checkbox"/>	<input type="checkbox"/>	<input type="checkbox"/>	<input type="checkbox"/>	<input type="checkbox"/>	<input type="checkbox"/>
54	66	MOD8HWD5466P	3474	3635	3798	<input type="checkbox"/>	<input type="checkbox"/>	<input type="checkbox"/>	<input type="checkbox"/>	<input type="checkbox"/>	<input type="checkbox"/>	<input type="checkbox"/>	<input type="checkbox"/>
54	72	MOD8HWD5472P	3474	3635	3798	<input type="checkbox"/>	<input type="checkbox"/>	<input type="checkbox"/>	<input type="checkbox"/>	<input type="checkbox"/>	<input type="checkbox"/>	<input type="checkbox"/>	<input type="checkbox"/>
54	78	MOD8HWD5478P	3638	3799	3978	<input type="checkbox"/>	<input type="checkbox"/>	<input type="checkbox"/>	<input type="checkbox"/>	<input type="checkbox"/>	<input type="checkbox"/>	<input type="checkbox"/>	<input type="checkbox"/>
54	84	MOD8HWD5484P	3638	3799	3978	<input type="checkbox"/>	<input type="checkbox"/>	<input type="checkbox"/>	<input type="checkbox"/>	<input type="checkbox"/>	<input type="checkbox"/>	<input type="checkbox"/>	<input type="checkbox"/>
54	90	MOD8HWD5490P	4360	4521	4700	<input type="checkbox"/>	<input type="checkbox"/>	<input type="checkbox"/>	<input type="checkbox"/>	<input type="checkbox"/>	<input type="checkbox"/>	<input type="checkbox"/>	<input type="checkbox"/>
54	96	MOD8HWD5496P	4360	4521	4700	<input type="checkbox"/>	<input type="checkbox"/>	<input type="checkbox"/>	<input type="checkbox"/>	<input type="checkbox"/>	<input type="checkbox"/>	<input type="checkbox"/>	<input type="checkbox"/>

RESOURCES

HUTCH ACCESSORIES	66
FINISHES	76

35 inch high Hutch aligns with 65 inch high Storage Towers. 42 inch high Hutch aligns with 72 inch high Storage Towers. 54 inch high Hutch aligns with 84 inch high Storage Towers.

42 and 54 inch high Hutch over 72 inches long must be attached to a wall or to the back of another Hutch.

Hutches must be supported with an undersurface panel directly below each end (Modesty Panel okay).

Hutches ship fully assembled.

PULLS

Pull Style	Pull Color	Pull Code
	Black	12
	Silver	13
	Black	30
	Silver	31
	Touchlatch	NN

Locks

Randomly keyed locks "L" are standard on all storage units. Storage locks can be specified keyed alike "U" if required. Keyed alike option is field installed.

EDGES

Edge Profile	Edge Code
WoodPlus & 3mm	
Smooth	S
Reeded	R
NeoClassic	E
Detailed	
Radius	D
Beveled	B
Transitional	T
Reeded	R
Classic	C

For a closer look at edge styles, visit our website.

HUTCH		PRODUCT	EDGE				FINISHES		
H / W			Wood Plus	3mm	Detailed	Edge Profile	Surface	Edge	Case
			P	W	D	See Below			
			\$	\$	\$				
42	36	MOD8HGD4236P	2289	2450	2613				
42	42	MOD8HGD4242P	2455	2616	2779				
42	48	MOD8HGD4248P	2616	2777	2939				
42	54	MOD8HGD4254P	3240	3400	3563				
42	60	MOD8HGD4260P	3240	3400	3563				
42	66	MOD8HGD4266P	3431	3592	3755				
42	72	MOD8HGD4272P	3502	3662	3825				
42	78	MOD8HGD4278P	3714	3875	4054				
42	84	MOD8HGD4284P	3784	3944	4123				
42	90	MOD8HGD4290P	4463	4623	4802				
42	96	MOD8HGD4296P	4623	4784	4963				
54	36	MOD8HGD5436P	3243	3404	3567				
54	42	MOD8HGD5442P	3496	3657	3820				
54	48	MOD8HGD5448P	3736	3897	4060				
54	54	MOD8HGD5454P	4680	4841	5003				
54	60	MOD8HGD5460P	4680	4841	5003				
54	66	MOD8HGD5466P	4970	5130	5293				
54	72	MOD8HGD5472P	5075	5236	5398				
54	78	MOD8HGD5478P	5338	5499	5678				
54	84	MOD8HGD5484P	5441	5602	5781				
54	90	MOD8HGD5490P	6461	6622	6801				
54	96	MOD8HGD5496P	6701	6862	7041				

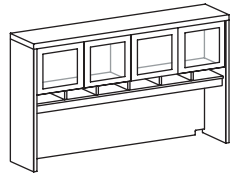

GLASS DOOR W/PAPERSHELF

RESOURCES

HUTCH ACCESSORIES

66

FINISHES

76

Glass doors available with touch latch only.

42 inch high Hutch aligns with 72 inch high Storage Towers. 54 inch high Hutch aligns with 84 inch high Storage Towers.

42 and 54 inch high Hutches over 72 inches long must be attached to a wall or to the back of another Hutch.

Hutches must be supported with an undersurface panel directly below each end (Modesty Panel okay).

Hutches ship fully assembled.

EDGES

Edge Profile

Edge Code

WoodPlus & 3mm



Smooth

S

Reeded

R

NeoClassic

E

Detailed



Radius

D

Beveled

B

Transitional

T

Reeded

R

Classic

C

For a closer look at edge styles, visit our website.

TRANSACTION TOPS

D / W / H	PRODUCT	Left = L Right = R	EDGE			Edge Profile <i>See Below</i>	FINISHES		
			Wood Plus P	3mm W	Detailed D		Surface	Edge	Case
			\$	\$	\$				
- 15 35	MOD8HQR35	<input type="checkbox"/>	1042	1203	1587	<input type="checkbox"/>	<input type="checkbox"/>	<input type="checkbox"/>	<input type="checkbox"/>
- 15 42	MOD8HQR42	<input type="checkbox"/>	1094	1255	1639	<input type="checkbox"/>	<input type="checkbox"/>	<input type="checkbox"/>	<input type="checkbox"/>
12 36 14	MOD8TT36	<input type="checkbox"/>	566	734	949	<input type="checkbox"/>	<input type="checkbox"/>	<input type="checkbox"/>	<input type="checkbox"/>
12 42 14	MOD8TT42	<input type="checkbox"/>	590	757	972	<input type="checkbox"/>	<input type="checkbox"/>	<input type="checkbox"/>	<input type="checkbox"/>
12 48 14	MOD8TT48	<input type="checkbox"/>	590	757	972	<input type="checkbox"/>	<input type="checkbox"/>	<input type="checkbox"/>	<input type="checkbox"/>
12 54 14	MOD8TT54	<input type="checkbox"/>	630	797	1012	<input type="checkbox"/>	<input type="checkbox"/>	<input type="checkbox"/>	<input type="checkbox"/>
12 60 14	MOD8TT60	<input type="checkbox"/>	630	836	1030	<input type="checkbox"/>	<input type="checkbox"/>	<input type="checkbox"/>	<input type="checkbox"/>
12 66 14	MOD8TT66	<input type="checkbox"/>	662	868	1062	<input type="checkbox"/>	<input type="checkbox"/>	<input type="checkbox"/>	<input type="checkbox"/>
12 72 14	MOD8TT72	<input type="checkbox"/>	662	868	1062	<input type="checkbox"/>	<input type="checkbox"/>	<input type="checkbox"/>	<input type="checkbox"/>
12 78 14	MOD8TT78	<input type="checkbox"/>	770	937	1187	<input type="checkbox"/>	<input type="checkbox"/>	<input type="checkbox"/>	<input type="checkbox"/>
12 84 14	MOD8TT84	<input type="checkbox"/>	770	937	1187	<input type="checkbox"/>	<input type="checkbox"/>	<input type="checkbox"/>	<input type="checkbox"/>
12 90 14	MOD8TT90	<input type="checkbox"/>	914	1082	1331	<input type="checkbox"/>	<input type="checkbox"/>	<input type="checkbox"/>	<input type="checkbox"/>
12 96 14	MOD8TT96	<input type="checkbox"/>	914	1082	1331	<input type="checkbox"/>	<input type="checkbox"/>	<input type="checkbox"/>	<input type="checkbox"/>
12 102 14	MOD8TT102	<input type="checkbox"/>	923	1091	1354	<input type="checkbox"/>	<input type="checkbox"/>	<input type="checkbox"/>	<input type="checkbox"/>
12 108 14	MOD8TT108	<input type="checkbox"/>	923	1091	1354	<input type="checkbox"/>	<input type="checkbox"/>	<input type="checkbox"/>	<input type="checkbox"/>
12 114 14	MOD8TT114	<input type="checkbox"/>	931	1099	1362	<input type="checkbox"/>	<input type="checkbox"/>	<input type="checkbox"/>	<input type="checkbox"/>
12 120 14	MOD8TT120	<input type="checkbox"/>	931	1099	1362	<input type="checkbox"/>	<input type="checkbox"/>	<input type="checkbox"/>	<input type="checkbox"/>



QUARTER ROUND

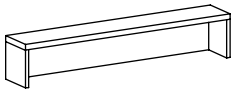

TOP

RESOURCES

HUTCH ACCESSORIES	66
FINISHES	76

All Transaction surfaces ship ready to assemble.

Specify left/right based on primary surface.

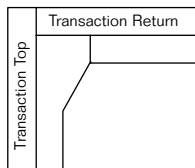
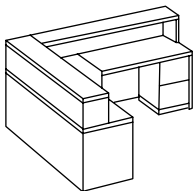

OPTIONS

Grain Direction (Quarter Round Only)
Quarter Round grain direction is based on the hand (Left or Right) specified.

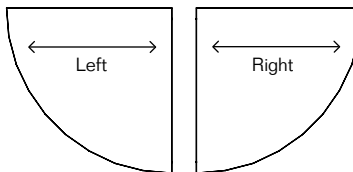

EDGES

Edge Profile		Edge Code
WoodPlus & 3mm		
	Smooth	S
	Reeded	R
	NeoClassic	E
Detailed		
	Radius	D
	Beveled	B
	Transitional	T
	Reeded	R
	Classic	C

For a closer look at edge styles, visit our website.

TRANSACTION TOPS

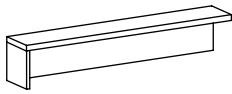
**RETURN**

Left Hand Shown

D / W / H

12 36 14
12 42 14
12 48 14
12 54 14
12 60 14
12 66 14
12 72 14
12 78 14
12 84 14
12 90 14
12 96 14
12 102 14
12 108 14
12 114 14
12 120 14

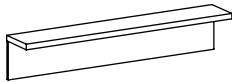
**CONNECTOR**

12 36 14
12 42 14
12 48 14
12 54 14
12 60 14
12 66 14
12 72 14
12 78 14
12 84 14
12 90 14
12 96 14
12 102 14
12 108 14
12 114 14
12 120 14

PRODUCT	EDGE				FINISHES		
	Wood Plus	3mm	Detailed	Edge Profile	Surface	Edge	Case
	P	W	D	See Below			
	\$	\$	\$				
MOD8TR36	394	504	697	<input type="checkbox"/>	<input type="checkbox"/>	<input type="checkbox"/>	<input type="checkbox"/>
MOD8TR42	419	528	721	<input type="checkbox"/>	<input type="checkbox"/>	<input type="checkbox"/>	<input type="checkbox"/>
MOD8TR48	419	528	721	<input type="checkbox"/>	<input type="checkbox"/>	<input type="checkbox"/>	<input type="checkbox"/>
MOD8TR54	460	570	763	<input type="checkbox"/>	<input type="checkbox"/>	<input type="checkbox"/>	<input type="checkbox"/>
MOD8TR60	460	571	779	<input type="checkbox"/>	<input type="checkbox"/>	<input type="checkbox"/>	<input type="checkbox"/>
MOD8TR66	494	605	812	<input type="checkbox"/>	<input type="checkbox"/>	<input type="checkbox"/>	<input type="checkbox"/>
MOD8TR72	494	605	812	<input type="checkbox"/>	<input type="checkbox"/>	<input type="checkbox"/>	<input type="checkbox"/>
MOD8TR78	576	687	915	<input type="checkbox"/>	<input type="checkbox"/>	<input type="checkbox"/>	<input type="checkbox"/>
MOD8TR84	576	687	915	<input type="checkbox"/>	<input type="checkbox"/>	<input type="checkbox"/>	<input type="checkbox"/>
MOD8TR90	683	794	1023	<input type="checkbox"/>	<input type="checkbox"/>	<input type="checkbox"/>	<input type="checkbox"/>
MOD8TR96	683	794	1023	<input type="checkbox"/>	<input type="checkbox"/>	<input type="checkbox"/>	<input type="checkbox"/>
MOD8TR102	757	876	1212	<input type="checkbox"/>	<input type="checkbox"/>	<input type="checkbox"/>	<input type="checkbox"/>
MOD8TR108	757	876	1212	<input type="checkbox"/>	<input type="checkbox"/>	<input type="checkbox"/>	<input type="checkbox"/>
MOD8TR114	804	923	1259	<input type="checkbox"/>	<input type="checkbox"/>	<input type="checkbox"/>	<input type="checkbox"/>
MOD8TR120	804	923	1259	<input type="checkbox"/>	<input type="checkbox"/>	<input type="checkbox"/>	<input type="checkbox"/>
MOD8TC36	290	347	561	<input type="checkbox"/>	<input type="checkbox"/>	<input type="checkbox"/>	<input type="checkbox"/>
MOD8TC42	312	369	583	<input type="checkbox"/>	<input type="checkbox"/>	<input type="checkbox"/>	<input type="checkbox"/>
MOD8TC48	312	369	583	<input type="checkbox"/>	<input type="checkbox"/>	<input type="checkbox"/>	<input type="checkbox"/>
MOD8TC54	357	414	628	<input type="checkbox"/>	<input type="checkbox"/>	<input type="checkbox"/>	<input type="checkbox"/>
MOD8TC60	357	414	643	<input type="checkbox"/>	<input type="checkbox"/>	<input type="checkbox"/>	<input type="checkbox"/>
MOD8TC66	386	443	672	<input type="checkbox"/>	<input type="checkbox"/>	<input type="checkbox"/>	<input type="checkbox"/>
MOD8TC72	386	443	672	<input type="checkbox"/>	<input type="checkbox"/>	<input type="checkbox"/>	<input type="checkbox"/>
MOD8TC78	471	527	777	<input type="checkbox"/>	<input type="checkbox"/>	<input type="checkbox"/>	<input type="checkbox"/>
MOD8TC84	471	527	777	<input type="checkbox"/>	<input type="checkbox"/>	<input type="checkbox"/>	<input type="checkbox"/>
MOD8TC90	557	614	863	<input type="checkbox"/>	<input type="checkbox"/>	<input type="checkbox"/>	<input type="checkbox"/>
MOD8TC96	557	614	863	<input type="checkbox"/>	<input type="checkbox"/>	<input type="checkbox"/>	<input type="checkbox"/>
MOD8TC102	627	683	946	<input type="checkbox"/>	<input type="checkbox"/>	<input type="checkbox"/>	<input type="checkbox"/>
MOD8TC108	627	683	946	<input type="checkbox"/>	<input type="checkbox"/>	<input type="checkbox"/>	<input type="checkbox"/>
MOD8TC114	677	734	997	<input type="checkbox"/>	<input type="checkbox"/>	<input type="checkbox"/>	<input type="checkbox"/>
MOD8TC120	677	734	997	<input type="checkbox"/>	<input type="checkbox"/>	<input type="checkbox"/>	<input type="checkbox"/>

RESOURCES

OPTIONS

EDGES

HUTCH ACCESSORIES

66

FINISHES

76

All Transaction surfaces ship ready to assemble.

Transaction Connector is used between two surfaces.

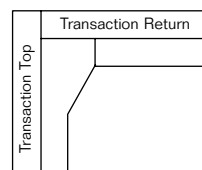
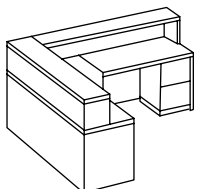
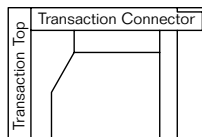
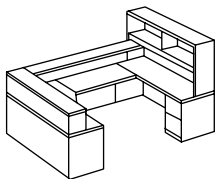

Edge Profile

Edge Code

WoodPlus & 3mm



Smooth

S

Reeded

R

NeoClassic

E

Detailed



Radius

D

Beveled

B

Transitional

T

Reeded



R

Classic

C

For a closer look at edge styles, visit our website.

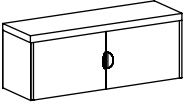
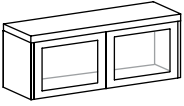
WALL MOUNTED

H / W	PRODUCT	EDGE				OPTIONS			FINISHES			
		Wood Plus P	3mm W	Detailed D	Edge Profile See Below	Lock=L Alike=U See Below	Pull See Below	Surface	Edge	Case	Face	
 WOOD DOOR	30 MOD80WD30	876	931	1094	<input type="checkbox"/>	<input type="checkbox"/>	<input type="checkbox"/> <input type="checkbox"/>	<input type="checkbox"/> <input type="checkbox"/>	<input type="checkbox"/> <input type="checkbox"/>	<input type="checkbox"/> <input type="checkbox"/>	<input type="checkbox"/> <input type="checkbox"/>	
	36 MOD80WD36	897	952	1115	<input type="checkbox"/>	<input type="checkbox"/>	<input type="checkbox"/> <input type="checkbox"/>	<input type="checkbox"/> <input type="checkbox"/>	<input type="checkbox"/> <input type="checkbox"/>	<input type="checkbox"/> <input type="checkbox"/>	<input type="checkbox"/> <input type="checkbox"/>	
	42 MOD80WD42	979	1034	1197	<input type="checkbox"/>	<input type="checkbox"/>	<input type="checkbox"/> <input type="checkbox"/>	<input type="checkbox"/> <input type="checkbox"/>	<input type="checkbox"/> <input type="checkbox"/>	<input type="checkbox"/> <input type="checkbox"/>	<input type="checkbox"/> <input type="checkbox"/>	
	48 MOD80WD48	1122	1177	1340	<input type="checkbox"/>	<input type="checkbox"/>	<input type="checkbox"/> <input type="checkbox"/>	<input type="checkbox"/> <input type="checkbox"/>	<input type="checkbox"/> <input type="checkbox"/>	<input type="checkbox"/> <input type="checkbox"/>	<input type="checkbox"/> <input type="checkbox"/>	
	54 MOD80WD54	1324	1380	1542	<input type="checkbox"/>	<input type="checkbox"/>	<input type="checkbox"/> <input type="checkbox"/>	<input type="checkbox"/> <input type="checkbox"/>	<input type="checkbox"/> <input type="checkbox"/>	<input type="checkbox"/> <input type="checkbox"/>	<input type="checkbox"/> <input type="checkbox"/>	
	60 MOD80WD60	1440	1495	1658	<input type="checkbox"/>	<input type="checkbox"/>	<input type="checkbox"/> <input type="checkbox"/>	<input type="checkbox"/> <input type="checkbox"/>	<input type="checkbox"/> <input type="checkbox"/>	<input type="checkbox"/> <input type="checkbox"/>	<input type="checkbox"/> <input type="checkbox"/>	
 GLASS DOOR	30 MOD80GD30	1348	1404	1567	<input type="checkbox"/>	-	-	<input type="checkbox"/> <input type="checkbox"/>	<input type="checkbox"/> <input type="checkbox"/>	<input type="checkbox"/> <input type="checkbox"/>	-	
	36 MOD80GD36	1403	1458	1621	<input type="checkbox"/>	-	-	<input type="checkbox"/> <input type="checkbox"/>	<input type="checkbox"/> <input type="checkbox"/>	<input type="checkbox"/> <input type="checkbox"/>	-	
	42 MOD80GD42	1554	1609	1772	<input type="checkbox"/>	-	-	<input type="checkbox"/> <input type="checkbox"/>	<input type="checkbox"/> <input type="checkbox"/>	<input type="checkbox"/> <input type="checkbox"/>	-	
	48 MOD80GD48	1895	1950	2113	<input type="checkbox"/>	-	-	<input type="checkbox"/> <input type="checkbox"/>	<input type="checkbox"/> <input type="checkbox"/>	<input type="checkbox"/> <input type="checkbox"/>	-	
	54 MOD80GD54	2252	2307	2470	<input type="checkbox"/>	-	-	<input type="checkbox"/> <input type="checkbox"/>	<input type="checkbox"/> <input type="checkbox"/>	<input type="checkbox"/> <input type="checkbox"/>	-	
	60 MOD80GD60	2367	2423	2585	<input type="checkbox"/>	-	-	<input type="checkbox"/> <input type="checkbox"/>	<input type="checkbox"/> <input type="checkbox"/>	<input type="checkbox"/> <input type="checkbox"/>	-	
 SEMI ENCLOSED	30 MOD80ES30	555	610	-	S	-	-	-	-	<input type="checkbox"/> <input type="checkbox"/>	-	
	36 MOD80ES36	598	653	-	S	-	-	-	-	<input type="checkbox"/> <input type="checkbox"/>	-	
	42 MOD80ES42	719	774	-	S	-	-	-	-	<input type="checkbox"/> <input type="checkbox"/>	-	
	48 MOD80ES48	748	803	-	S	-	-	-	-	<input type="checkbox"/> <input type="checkbox"/>	-	

RESOURCES

HUTCH ACCESSORIES



66

FINISHES

76

Price includes wall mount brackets.









PULLS

Pull Style	Pull Color	Pull Code
	Black Silver	12 13
	Black Silver	30 31
	Touchlatch	NN

Locks

Randomly keyed locks "L" are standard on all storage units. Storage locks can be specified keyed alike "U" if required. Keyed alike option is field installed.

EDGES

Edge Profile	Edge Code
WoodPlus & 3mm	
 Smooth	S
 Reeded	R
 NeoClassic	E
Detailed	
 Radius	D
 Beveled	B
 Transitional	T
 Reeded	R
 Classic	C

For a closer look at edge styles, visit our website.

NOTES

For Customer Service Inquiries, please contact:

800.426.1202

360.394.1322 *fax*

www.magnadesign.com

STORAGE TOWERS

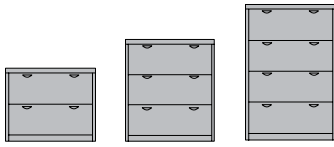

STORAGE TOWERS

Lateral File	52
Wardrobe	56
Audio/Video	58
Bookcase	61
Library Shelving	63

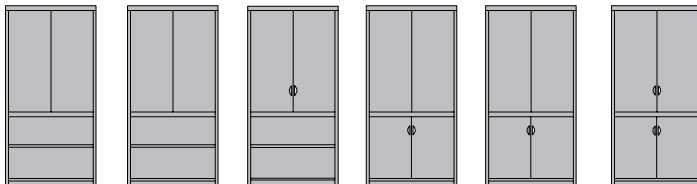
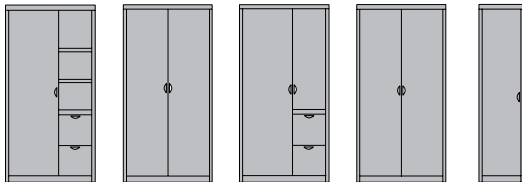
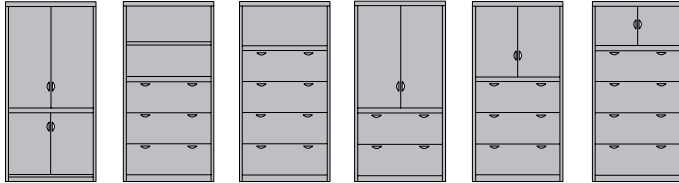

STORAGE TOWER - LATERAL

D / W / H	PRODUCT	EDGE				OPTIONS			FINISHES			
		Wood Plus	3mm	Detailed	Edge Profile	Lock= L Alike= U	Pull	Surface	Edge	Case	Face	
		P	W	D	See Below	See Below	See Below					
		\$	\$	\$								
24 30 29	MOD8ST2L243029	1900	2068	2235	<input type="checkbox"/>	<input type="checkbox"/>	<input type="checkbox"/>	<input type="checkbox"/>	<input type="checkbox"/>	<input type="checkbox"/>	<input type="checkbox"/>	
	MOD8ST2L243629	1900	2068	2235	<input type="checkbox"/>	<input type="checkbox"/>	<input type="checkbox"/>	<input type="checkbox"/>	<input type="checkbox"/>	<input type="checkbox"/>	<input type="checkbox"/>	
24 30 41	MOD8ST3L243041	2298	2465	2633	<input type="checkbox"/>	<input type="checkbox"/>	<input type="checkbox"/>	<input type="checkbox"/>	<input type="checkbox"/>	<input type="checkbox"/>	<input type="checkbox"/>	
	MOD8ST3L243641	2298	2465	2633	<input type="checkbox"/>	<input type="checkbox"/>	<input type="checkbox"/>	<input type="checkbox"/>	<input type="checkbox"/>	<input type="checkbox"/>	<input type="checkbox"/>	
24 30 53	MOD8ST4L243053	2681	2849	3016	<input type="checkbox"/>	<input type="checkbox"/>	<input type="checkbox"/>	<input type="checkbox"/>	<input type="checkbox"/>	<input type="checkbox"/>	<input type="checkbox"/>	
	MOD8ST4L243653	2681	2849	3016	<input type="checkbox"/>	<input type="checkbox"/>	<input type="checkbox"/>	<input type="checkbox"/>	<input type="checkbox"/>	<input type="checkbox"/>	<input type="checkbox"/>	

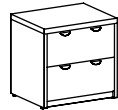

2 HIGH LATERAL

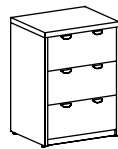

3 HIGH LATERAL

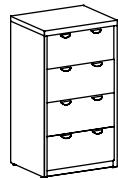



4 HIGH LATERAL

RESOURCES

STORAGE ACCESSORIES	69
FINISHES	76









PULLS

Pull Style	Pull Color	Pull Code
	Black Silver	12 13
	Black Silver	30 31

Locks

Randomly keyed locks "**L**" are standard on all storage units. Storage locks can be specified keyed alike "**U**" if required. Keyed alike option is field installed.

EDGES

Edge Profile	Edge Code
WoodPlus & 3mm	
 Smooth	S
 Reeded	R
 NeoClassic	E
Detailed	
 Radius	D
 Beveled	B
 Transitional	T
 Reeded	R
 Classic	C

For a closer look at edge styles, visit our website.

STORAGE TOWER - LATERALS

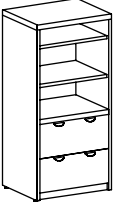
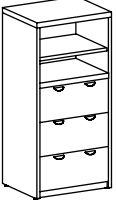
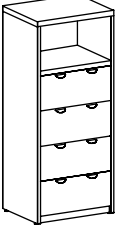

D / W / H			PRODUCT	EDGE				OPTIONS			FINISHES			
				Wood Plus	3mm	Detailed	Edge Profile	Lock=L Alike=U	Pull	Surface	Edge	Case	Face	
				P	W	D	See Below	See Below	See Below					
				\$	\$	\$								
	24	30	65	MOD8ST2LOP243065	2537	2760	2949	<input type="checkbox"/>	<input type="checkbox"/>	<input type="checkbox"/>	<input type="checkbox"/>	<input type="checkbox"/>	<input type="checkbox"/>	
	24	36	65	MOD8ST2LOP243665	2603	2826	3015	<input type="checkbox"/>	<input type="checkbox"/>	<input type="checkbox"/>	<input type="checkbox"/>	<input type="checkbox"/>	<input type="checkbox"/>	
	24	30	72	MOD8ST2LOP243072	2592	2815	3005	<input type="checkbox"/>	<input type="checkbox"/>	<input type="checkbox"/>	<input type="checkbox"/>	<input type="checkbox"/>	<input type="checkbox"/>	
	24	36	72	MOD8ST2LOP243672	2657	2880	3069	<input type="checkbox"/>	<input type="checkbox"/>	<input type="checkbox"/>	<input type="checkbox"/>	<input type="checkbox"/>	<input type="checkbox"/>	
	24	30	84	MOD8ST2LOP243084	2729	2952	3141	<input type="checkbox"/>	<input type="checkbox"/>	<input type="checkbox"/>	<input type="checkbox"/>	<input type="checkbox"/>	<input type="checkbox"/>	
	24	36	84	MOD8ST2LOP243684	2804	3027	3216	<input type="checkbox"/>	<input type="checkbox"/>	<input type="checkbox"/>	<input type="checkbox"/>	<input type="checkbox"/>	<input type="checkbox"/>	
OPEN / TWO LATERAL														
	24	30	65	MOD8ST3LOP243065	2893	3116	3305	<input type="checkbox"/>	<input type="checkbox"/>	<input type="checkbox"/>	<input type="checkbox"/>	<input type="checkbox"/>	<input type="checkbox"/>	
	24	36	65	MOD8ST3LOP243665	2960	3183	3372	<input type="checkbox"/>	<input type="checkbox"/>	<input type="checkbox"/>	<input type="checkbox"/>	<input type="checkbox"/>	<input type="checkbox"/>	
	24	30	72	MOD8ST3LOP243072	2947	3170	3359	<input type="checkbox"/>	<input type="checkbox"/>	<input type="checkbox"/>	<input type="checkbox"/>	<input type="checkbox"/>	<input type="checkbox"/>	
	24	36	72	MOD8ST3LOP243672	3014	3237	3426	<input type="checkbox"/>	<input type="checkbox"/>	<input type="checkbox"/>	<input type="checkbox"/>	<input type="checkbox"/>	<input type="checkbox"/>	
	24	30	84	MOD8ST3LOP243084	3087	3310	3499	<input type="checkbox"/>	<input type="checkbox"/>	<input type="checkbox"/>	<input type="checkbox"/>	<input type="checkbox"/>	<input type="checkbox"/>	
	24	36	84	MOD8ST3LOP243684	3159	3382	3572	<input type="checkbox"/>	<input type="checkbox"/>	<input type="checkbox"/>	<input type="checkbox"/>	<input type="checkbox"/>	<input type="checkbox"/>	
OPEN / THREE LATERAL														
	24	30	72	MOD8ST4LOP243072	3389	3612	3802	<input type="checkbox"/>	<input type="checkbox"/>	<input type="checkbox"/>	<input type="checkbox"/>	<input type="checkbox"/>	<input type="checkbox"/>	
	24	36	72	MOD8ST4LOP243672	3462	3685	3874	<input type="checkbox"/>	<input type="checkbox"/>	<input type="checkbox"/>	<input type="checkbox"/>	<input type="checkbox"/>	<input type="checkbox"/>	
	24	30	84	MOD8ST4LOP243084	3444	3666	3856	<input type="checkbox"/>	<input type="checkbox"/>	<input type="checkbox"/>	<input type="checkbox"/>	<input type="checkbox"/>	<input type="checkbox"/>	
	24	36	84	MOD8ST4LOP243684	3517	3740	3930	<input type="checkbox"/>	<input type="checkbox"/>	<input type="checkbox"/>	<input type="checkbox"/>	<input type="checkbox"/>	<input type="checkbox"/>	
OPEN / FOUR LATERAL														

RESOURCES

STORAGE ACCESSORIES	69
FINISHES	76

Finish columns specify finishes for both the lower (lateral) and upper (shelves) portion of the unit.









PULLS

Pull Style	Pull Color	Pull Code
	Black Silver	12 13
	Black Silver	30 31

Locks

Randomly keyed locks "L" are standard on all storage units. Storage locks can be specified keyed alike "U" if required. Keyed alike option is field installed.

EDGES

Edge Profile	Edge Code
WoodPlus & 3mm	
 Smooth	S
 Reeded	R
 NeoClassic	E
Detailed	
 Radius	D
 Beveled	B
 Transitional	T
 Reeded	R
 Classic	C

For a closer look at edge styles, visit our website.

STORAGE TOWER - LATERALS

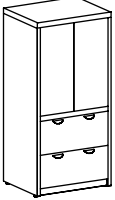
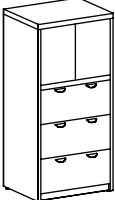
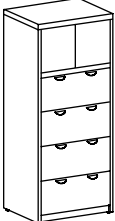
D / W / H			PRODUCT	EDGE				OPTIONS			FINISHES					
				Wood Plus	3mm	Detailed	Edge Profile	Lock=L Alike=U	Pull	Surface	Edge	Case	Face			
			P	W	D	See Below	See Below	See Below								
			\$	\$	\$											
	24	30	65	MOD8ST2LWD243065	2945	3168	3357	<input type="checkbox"/>	<input type="checkbox"/>	<input type="checkbox"/>	<input type="checkbox"/>	<input type="checkbox"/>	<input type="checkbox"/>	<input type="checkbox"/>	<input type="checkbox"/>	
	24	36	65	MOD8ST2LWD243665	3010	3233	3423	<input type="checkbox"/>	<input type="checkbox"/>	<input type="checkbox"/>	<input type="checkbox"/>	<input type="checkbox"/>	<input type="checkbox"/>	<input type="checkbox"/>	<input type="checkbox"/>	
	24	30	72	MOD8ST2LWD243072	3000	3223	3412	<input type="checkbox"/>	<input type="checkbox"/>	<input type="checkbox"/>	<input type="checkbox"/>	<input type="checkbox"/>	<input type="checkbox"/>	<input type="checkbox"/>	<input type="checkbox"/>	
	24	36	72	MOD8ST2LWD243672	3065	3288	3477	<input type="checkbox"/>	<input type="checkbox"/>	<input type="checkbox"/>	<input type="checkbox"/>	<input type="checkbox"/>	<input type="checkbox"/>	<input type="checkbox"/>	<input type="checkbox"/>	
	24	30	84	MOD8ST2LWD243084	3136	3359	3549	<input type="checkbox"/>	<input type="checkbox"/>	<input type="checkbox"/>	<input type="checkbox"/>	<input type="checkbox"/>	<input type="checkbox"/>	<input type="checkbox"/>	<input type="checkbox"/>	
	24	36	84	MOD8ST2LWD243684	3211	3434	3624	<input type="checkbox"/>	<input type="checkbox"/>	<input type="checkbox"/>	<input type="checkbox"/>	<input type="checkbox"/>	<input type="checkbox"/>	<input type="checkbox"/>	<input type="checkbox"/>	
WOOD DOORS / TWO LATERAL																
	24	30	65	MOD8ST3LWD243065	3300	3523	3713	<input type="checkbox"/>	<input type="checkbox"/>	<input type="checkbox"/>	<input type="checkbox"/>	<input type="checkbox"/>	<input type="checkbox"/>	<input type="checkbox"/>	<input type="checkbox"/>	
	24	36	65	MOD8ST3LWD243665	3367	3590	3780	<input type="checkbox"/>	<input type="checkbox"/>	<input type="checkbox"/>	<input type="checkbox"/>	<input type="checkbox"/>	<input type="checkbox"/>	<input type="checkbox"/>	<input type="checkbox"/>	
	24	30	72	MOD8ST3LWD243072	3355	3578	3767	<input type="checkbox"/>	<input type="checkbox"/>	<input type="checkbox"/>	<input type="checkbox"/>	<input type="checkbox"/>	<input type="checkbox"/>	<input type="checkbox"/>	<input type="checkbox"/>	
	24	36	72	MOD8ST3LWD243672	3422	3645	3834	<input type="checkbox"/>	<input type="checkbox"/>	<input type="checkbox"/>	<input type="checkbox"/>	<input type="checkbox"/>	<input type="checkbox"/>	<input type="checkbox"/>	<input type="checkbox"/>	
	24	30	84	MOD8ST3LWD243084	3494	3717	3907	<input type="checkbox"/>	<input type="checkbox"/>	<input type="checkbox"/>	<input type="checkbox"/>	<input type="checkbox"/>	<input type="checkbox"/>	<input type="checkbox"/>	<input type="checkbox"/>	
	24	36	84	MOD8ST3LWD243684	3567	3790	3979	<input type="checkbox"/>	<input type="checkbox"/>	<input type="checkbox"/>	<input type="checkbox"/>	<input type="checkbox"/>	<input type="checkbox"/>	<input type="checkbox"/>	<input type="checkbox"/>	
WOOD DOORS / THREE LATERAL																
	24	30	72	MOD8ST4LWD243072	3797	4020	4209	<input type="checkbox"/>	<input type="checkbox"/>	<input type="checkbox"/>	<input type="checkbox"/>	<input type="checkbox"/>	<input type="checkbox"/>	<input type="checkbox"/>	<input type="checkbox"/>	
	24	36	72	MOD8ST4LWD243672	3870	4093	4282	<input type="checkbox"/>	<input type="checkbox"/>	<input type="checkbox"/>	<input type="checkbox"/>	<input type="checkbox"/>	<input type="checkbox"/>	<input type="checkbox"/>	<input type="checkbox"/>	
	24	30	84	MOD8ST4LWD243084	3851	4074	4264	<input type="checkbox"/>	<input type="checkbox"/>	<input type="checkbox"/>	<input type="checkbox"/>	<input type="checkbox"/>	<input type="checkbox"/>	<input type="checkbox"/>	<input type="checkbox"/>	
	24	36	84	MOD8ST4LWD243684	3925	4148	4338	<input type="checkbox"/>	<input type="checkbox"/>	<input type="checkbox"/>	<input type="checkbox"/>	<input type="checkbox"/>	<input type="checkbox"/>	<input type="checkbox"/>	<input type="checkbox"/>	
	WOOD DOORS / FOUR LATERAL															

RESOURCES

PULLS

EDGES

STORAGE ACCESSORIES

69

FINISHES

76

Finish columns specify finishes for both the lower (lateral) and upper (shelves) portion of the unit.

Upper doors ship standard as non-locking touch latch, unless otherwise specified.

Pull and Lock columns specify the lower (lateral) portion of the unit only. To add matching locks and pulls to the top (door) portion, add a "P" to the end of the part number.

Pull Style

Pull Color

Pull Code

Black
Silver**12**
13Black
Silver**30**
31**Locks**

Randomly keyed locks "L" are standard on all storage units. Storage locks can be specified keyed alike "U" if required. Keyed alike option is field installed.

Edge Profile

Edge Code

WoodPlus & 3mm

Smooth

S

Reeded

R

NeoClassic

E**Detailed**

Radius

D

Beveled

B

Transitional

T

Reeded

R

Classic

C

For a closer look at edge styles, visit our website.

STORAGE TOWER - LATERALS

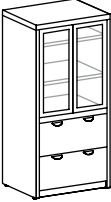
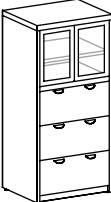
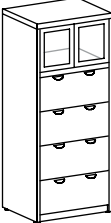

D / W / H	PRODUCT	EDGE				OPTIONS			FINISHES			
		Wood Plus P	3mm W	Detailed D	Edge Profile See Below	Lock=L Alike=U See Below	Pull See Below	Surface	Edge	Case	Face	
		\$	\$	\$								
 GLASS DOORS / TWO LATERAL	24 30 65	MOD8ST2LGD243065	3450	3673	3863	<input type="checkbox"/>	<input type="checkbox"/>	<input type="checkbox"/>	<input type="checkbox"/>	<input type="checkbox"/>	<input type="checkbox"/>	<input type="checkbox"/>
	24 36 65	MOD8ST2LGD243665	3516	3739	3929	<input type="checkbox"/>	<input type="checkbox"/>	<input type="checkbox"/>	<input type="checkbox"/>	<input type="checkbox"/>	<input type="checkbox"/>	<input type="checkbox"/>
	24 30 72	MOD8ST2LGD243072	3506	3729	3918	<input type="checkbox"/>	<input type="checkbox"/>	<input type="checkbox"/>	<input type="checkbox"/>	<input type="checkbox"/>	<input type="checkbox"/>	<input type="checkbox"/>
	24 36 72	MOD8ST2LGD243672	3571	3794	3983	<input type="checkbox"/>	<input type="checkbox"/>	<input type="checkbox"/>	<input type="checkbox"/>	<input type="checkbox"/>	<input type="checkbox"/>	<input type="checkbox"/>
	24 30 84	MOD8ST2LGD243084	3642	3865	4055	<input type="checkbox"/>	<input type="checkbox"/>	<input type="checkbox"/>	<input type="checkbox"/>	<input type="checkbox"/>	<input type="checkbox"/>	<input type="checkbox"/>
	24 36 84	MOD8ST2LGD243684	3717	3940	4130	<input type="checkbox"/>	<input type="checkbox"/>	<input type="checkbox"/>	<input type="checkbox"/>	<input type="checkbox"/>	<input type="checkbox"/>	<input type="checkbox"/>
 GLASS DOORS / THREE LATERAL	24 30 65	MOD8ST3LGD243065	3806	4029	4219	<input type="checkbox"/>	<input type="checkbox"/>	<input type="checkbox"/>	<input type="checkbox"/>	<input type="checkbox"/>	<input type="checkbox"/>	<input type="checkbox"/>
	24 36 65	MOD8ST3LGD243665	3873	4096	4286	<input type="checkbox"/>	<input type="checkbox"/>	<input type="checkbox"/>	<input type="checkbox"/>	<input type="checkbox"/>	<input type="checkbox"/>	<input type="checkbox"/>
	24 30 72	MOD8ST3LGD243072	3861	4083	4273	<input type="checkbox"/>	<input type="checkbox"/>	<input type="checkbox"/>	<input type="checkbox"/>	<input type="checkbox"/>	<input type="checkbox"/>	<input type="checkbox"/>
	24 36 72	MOD8ST3LGD243672	3927	4150	4340	<input type="checkbox"/>	<input type="checkbox"/>	<input type="checkbox"/>	<input type="checkbox"/>	<input type="checkbox"/>	<input type="checkbox"/>	<input type="checkbox"/>
	24 30 84	MOD8ST3LGD243084	4000	4223	4413	<input type="checkbox"/>	<input type="checkbox"/>	<input type="checkbox"/>	<input type="checkbox"/>	<input type="checkbox"/>	<input type="checkbox"/>	<input type="checkbox"/>
	24 36 84	MOD8ST3LGD243684	4073	4296	4485	<input type="checkbox"/>	<input type="checkbox"/>	<input type="checkbox"/>	<input type="checkbox"/>	<input type="checkbox"/>	<input type="checkbox"/>	<input type="checkbox"/>
 GLASS DOORS / FOUR LATERAL	24 30 72	MOD8ST4LGD243072	4303	4526	4715	<input type="checkbox"/>	<input type="checkbox"/>	<input type="checkbox"/>	<input type="checkbox"/>	<input type="checkbox"/>	<input type="checkbox"/>	<input type="checkbox"/>
	24 36 72	MOD8ST4LGD243672	4376	4599	4788	<input type="checkbox"/>	<input type="checkbox"/>	<input type="checkbox"/>	<input type="checkbox"/>	<input type="checkbox"/>	<input type="checkbox"/>	<input type="checkbox"/>
	24 30 84	MOD8ST4LGD243084	4357	4580	4769	<input type="checkbox"/>	<input type="checkbox"/>	<input type="checkbox"/>	<input type="checkbox"/>	<input type="checkbox"/>	<input type="checkbox"/>	<input type="checkbox"/>
	24 36 84	MOD8ST4LGD243684	4431	4654	4843	<input type="checkbox"/>	<input type="checkbox"/>	<input type="checkbox"/>	<input type="checkbox"/>	<input type="checkbox"/>	<input type="checkbox"/>	<input type="checkbox"/>

RESOURCES

STORAGE ACCESSORIES	69
FINISHES	76

Finish columns specify finishes for both the lower (lateral) and upper (shelves) portion of the unit.









PULLS

Pull Style	Pull Color	Pull Code
	Black Silver	12 13
	Black Silver	30 31

Locks

Randomly keyed locks "L" are standard on all storage units. Storage locks can be specified keyed alike "U" if required. Keyed alike option is field installed.

EDGES

Edge Profile	Edge Code
WoodPlus & 3mm	
 Smooth	S
 Reeded	R
 NeoClassic	E
Detailed	
 Radius	D
 Beveled	B
 Transitional	T
 Reeded	R
 Classic	C

For a closer look at edge styles, visit our website.

STORAGE TOWER - WARDROBE

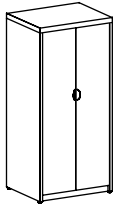

CLOSED WARDROBE

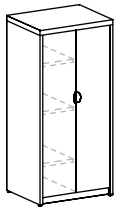
CLOSED WARDROBE
W/SHELVES

Right Hand Shown

D / W / H			PRODUCT	EDGE	OPTIONS	FINISHES						
D	W	H	Left = L Right = R	Wood Plus	3mm	Detailed	Edge Profile	Lock = L Alike = U	Pull	Edge	Case	Face
				P	W	D	See Below	See Below	See Below			
				\$	\$	\$						
24	18	65	MOD8STWC241865	<input type="checkbox"/>	1435	1658	1847	<input type="checkbox"/>	<input type="checkbox"/>	<input type="checkbox"/>	<input type="checkbox"/>	<input type="checkbox"/>
24	30	65	MOD8STWC243065	<input type="checkbox"/> N	1712	1935	2125	<input type="checkbox"/>	<input type="checkbox"/>	<input type="checkbox"/>	<input type="checkbox"/>	<input type="checkbox"/>
24	36	65	MOD8STWC243665	<input type="checkbox"/> N	1779	2002	2192	<input type="checkbox"/>	<input type="checkbox"/>	<input type="checkbox"/>	<input type="checkbox"/>	<input type="checkbox"/>
24	18	72	MOD8STWC241872	<input type="checkbox"/>	1488	1711	1900	<input type="checkbox"/>	<input type="checkbox"/>	<input type="checkbox"/>	<input type="checkbox"/>	<input type="checkbox"/>
24	30	72	MOD8STWC243072	<input type="checkbox"/> N	1769	1992	2181	<input type="checkbox"/>	<input type="checkbox"/>	<input type="checkbox"/>	<input type="checkbox"/>	<input type="checkbox"/>
24	36	72	MOD8STWC243672	<input type="checkbox"/> N	1832	2055	2245	<input type="checkbox"/>	<input type="checkbox"/>	<input type="checkbox"/>	<input type="checkbox"/>	<input type="checkbox"/>
24	18	84	MOD8STWC241884	<input type="checkbox"/>	1627	1850	2039	<input type="checkbox"/>	<input type="checkbox"/>	<input type="checkbox"/>	<input type="checkbox"/>	<input type="checkbox"/>
24	30	84	MOD8STWC243084	<input type="checkbox"/> N	1906	2129	2319	<input type="checkbox"/>	<input type="checkbox"/>	<input type="checkbox"/>	<input type="checkbox"/>	<input type="checkbox"/>
24	36	84	MOD8STWC243684	<input type="checkbox"/> N	1980	2203	2393	<input type="checkbox"/>	<input type="checkbox"/>	<input type="checkbox"/>	<input type="checkbox"/>	<input type="checkbox"/>
24	30	65	MOD8STWS243065	<input type="checkbox"/>	1933	2156	2366	<input type="checkbox"/>	<input type="checkbox"/>	<input type="checkbox"/>	<input type="checkbox"/>	<input type="checkbox"/>
24	36	65	MOD8STWS243665	<input type="checkbox"/>	1999	2222	2432	<input type="checkbox"/>	<input type="checkbox"/>	<input type="checkbox"/>	<input type="checkbox"/>	<input type="checkbox"/>
24	30	72	MOD8STWS243072	<input type="checkbox"/>	1987	2210	2399	<input type="checkbox"/>	<input type="checkbox"/>	<input type="checkbox"/>	<input type="checkbox"/>	<input type="checkbox"/>
24	36	72	MOD8STWS243672	<input type="checkbox"/>	2053	2276	2465	<input type="checkbox"/>	<input type="checkbox"/>	<input type="checkbox"/>	<input type="checkbox"/>	<input type="checkbox"/>
24	30	84	MOD8STWS243084	<input type="checkbox"/>	2126	2349	2559	<input type="checkbox"/>	<input type="checkbox"/>	<input type="checkbox"/>	<input type="checkbox"/>	<input type="checkbox"/>
24	36	84	MOD8STWS243684	<input type="checkbox"/>	2198	2421	2632	<input type="checkbox"/>	<input type="checkbox"/>	<input type="checkbox"/>	<input type="checkbox"/>	<input type="checkbox"/>

RESOURCES

PULLS

EDGES

STORAGE ACCESSORIES

69

FINISHES

76

18 inch wide units include one door, left/right hand is based on the door hinges.

Closed Wardrobe does not include a center divider, space is open with full hanging rail.

Pull Style	Pull Color	Pull Code
	Black Silver	12 13
	Black Silver	30 31
	Touchlatch	NN

Locks

Randomly keyed locks "L" are standard on all storage units. Storage locks can be specified keyed alike "U" if required. Keyed alike option is field installed.

Edge Profile	Edge Code
WoodPlus & 3mm	
	Smooth S
	Reeded R
	NeoClassic E
Detailed	
	Radius D
	Beveled B
	Transitional T
	Reeded R
	Classic C

For a closer look at edge styles, visit our website.

STORAGE TOWER - WARDROBE

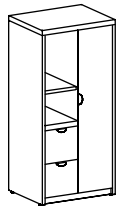

**OPEN TWO FILE /
CLOSED WARDROBE**

Right Hand Shown

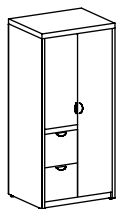

**CLOSED TWO FILE /
CLOSED WARDROBE**

Right Hand Shown

D / W / H			PRODUCT	Left = L Right = R	EDGE				OPTIONS			FINISHES			
					Wood Plus	3mm	Detailed	Edge Profile	Lock = L Alike = U	Pull	Surface	Edge	Case	Face	
							See Below	See Below	See Below						
					\$	\$	\$								
24	30	65	MOD8STW2FO243065	<input type="checkbox"/>	2417	2640	2850	<input type="checkbox"/>	<input type="checkbox"/>	<input type="checkbox"/>	<input type="checkbox"/>	<input type="checkbox"/>	<input type="checkbox"/>		
24	36	65	MOD8STW2FO243665	<input type="checkbox"/>	2481	2704	2915	<input type="checkbox"/>	<input type="checkbox"/>	<input type="checkbox"/>	<input type="checkbox"/>	<input type="checkbox"/>	<input type="checkbox"/>		
24	30	72	MOD8STW2FO243072	<input type="checkbox"/>	2472	2695	2885	<input type="checkbox"/>	<input type="checkbox"/>	<input type="checkbox"/>	<input type="checkbox"/>	<input type="checkbox"/>	<input type="checkbox"/>		
24	36	72	MOD8STW2FO243672	<input type="checkbox"/>	2537	2760	2949	<input type="checkbox"/>	<input type="checkbox"/>	<input type="checkbox"/>	<input type="checkbox"/>	<input type="checkbox"/>	<input type="checkbox"/>		
24	30	84	MOD8STW2FO243084	<input type="checkbox"/>	2607	2830	3040	<input type="checkbox"/>	<input type="checkbox"/>	<input type="checkbox"/>	<input type="checkbox"/>	<input type="checkbox"/>	<input type="checkbox"/>		
24	36	84	MOD8STW2FO243684	<input type="checkbox"/>	2681	2904	3114	<input type="checkbox"/>	<input type="checkbox"/>	<input type="checkbox"/>	<input type="checkbox"/>	<input type="checkbox"/>	<input type="checkbox"/>		
24	30	65	MOD8STW2FC243065	<input type="checkbox"/>	2625	2848	3058	<input type="checkbox"/>	<input type="checkbox"/>	<input type="checkbox"/>	<input type="checkbox"/>	<input type="checkbox"/>	<input type="checkbox"/>		
24	36	65	MOD8STW2FC243665	<input type="checkbox"/>	2689	2912	3122	<input type="checkbox"/>	<input type="checkbox"/>	<input type="checkbox"/>	<input type="checkbox"/>	<input type="checkbox"/>	<input type="checkbox"/>		
24	30	72	MOD8STW2FC243072	<input type="checkbox"/>	2680	2903	3092	<input type="checkbox"/>	<input type="checkbox"/>	<input type="checkbox"/>	<input type="checkbox"/>	<input type="checkbox"/>	<input type="checkbox"/>		
24	36	72	MOD8STW2FC243672	<input type="checkbox"/>	2745	2968	3157	<input type="checkbox"/>	<input type="checkbox"/>	<input type="checkbox"/>	<input type="checkbox"/>	<input type="checkbox"/>	<input type="checkbox"/>		
24	30	84	MOD8STW2FC243084	<input type="checkbox"/>	2815	3038	3248	<input type="checkbox"/>	<input type="checkbox"/>	<input type="checkbox"/>	<input type="checkbox"/>	<input type="checkbox"/>	<input type="checkbox"/>		
24	36	84	MOD8STW2FC243684	<input type="checkbox"/>	2889	3112	3322	<input type="checkbox"/>	<input type="checkbox"/>	<input type="checkbox"/>	<input type="checkbox"/>	<input type="checkbox"/>	<input type="checkbox"/>		

RESOURCES

STORAGE ACCESSORIES	69
FINISHES	76

Surface and Edge specifies finishes for both the storage surface and the complete cabinet surface.

Two File Wardrobe units include one adjustable shelf behind the smaller upper door.

PULLS

Pull Style	Pull Color	Pull Code
	Black Silver	12 13
	Black Silver	30 31

Locks

Randomly keyed locks "L" are standard on all storage units. Storage locks can be specified keyed alike "U" if required. Keyed alike option is field installed.

EDGES

Edge Profile	Edge Code
WoodPlus & 3mm	
Smooth	S
Reeded	R
NeoClassic	E
Detailed	
Radius	D
Beveled	B
Transitional	T
Reeded	R
Classic	C

For a closer look at edge styles, visit our website.

STORAGE TOWER - AUDIO/VIDEO

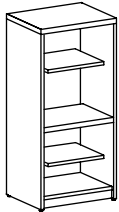

AUDIO VIDEO OPEN / OPEN

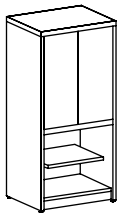

AUDIO VIDEO OPEN / POCKET DOOR

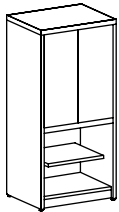

AUDIO VIDEO OPEN / WOOD DOOR

D / W / H

D / W / H	PRODUCT	EDGE				OPTIONS			FINISHES			
		Wood Plus	3mm	Detailed	Edge Profile	Lock=L Alike=U	Pull	Surface	Edge	Case	Face	
		P	W	D	See Below	See Below	See Below					
		\$	\$	\$								
24 30 65	MOD8STAVOPOP243065	1541	1764	1954	<input type="checkbox"/>	-	-	<input type="checkbox"/>	<input type="checkbox"/>	<input type="checkbox"/>	<input type="checkbox"/>	-
24 36 65	MOD8STAVOPOP243665	1608	1831	2021	<input type="checkbox"/>	-	-	<input type="checkbox"/>	<input type="checkbox"/>	<input type="checkbox"/>	<input type="checkbox"/>	-
24 30 72	MOD8STAVOPOP243072	1598	1821	2010	<input type="checkbox"/>	-	-	<input type="checkbox"/>	<input type="checkbox"/>	<input type="checkbox"/>	<input type="checkbox"/>	-
24 36 72	MOD8STAVOPOP243672	1663	1885	2075	<input type="checkbox"/>	-	-	<input type="checkbox"/>	<input type="checkbox"/>	<input type="checkbox"/>	<input type="checkbox"/>	-
24 30 84	MOD8STAVOPOP243084	1733	1956	2145	<input type="checkbox"/>	-	-	<input type="checkbox"/>	<input type="checkbox"/>	<input type="checkbox"/>	<input type="checkbox"/>	-
24 36 84	MOD8STAVOPOP243684	1808	2031	2220	<input type="checkbox"/>	-	-	<input type="checkbox"/>	<input type="checkbox"/>	<input type="checkbox"/>	<input type="checkbox"/>	-
24 30 65	MOD8STAVOPPD243065	2697	2920	3110	<input type="checkbox"/>	<input type="checkbox"/>	<input type="checkbox"/>	<input type="checkbox"/>	<input type="checkbox"/>	<input type="checkbox"/>	<input type="checkbox"/>	<input type="checkbox"/>
24 36 65	MOD8STAVOPPD243665	2764	2987	3177	<input type="checkbox"/>	<input type="checkbox"/>	<input type="checkbox"/>	<input type="checkbox"/>	<input type="checkbox"/>	<input type="checkbox"/>	<input type="checkbox"/>	<input type="checkbox"/>
24 30 72	MOD8STAVOPPD243072	2754	2977	3166	<input type="checkbox"/>	<input type="checkbox"/>	<input type="checkbox"/>	<input type="checkbox"/>	<input type="checkbox"/>	<input type="checkbox"/>	<input type="checkbox"/>	<input type="checkbox"/>
24 36 72	MOD8STAVOPPD243672	2819	3042	3231	<input type="checkbox"/>	<input type="checkbox"/>	<input type="checkbox"/>	<input type="checkbox"/>	<input type="checkbox"/>	<input type="checkbox"/>	<input type="checkbox"/>	<input type="checkbox"/>
24 30 84	MOD8STAVOPPD243084	2889	3112	3301	<input type="checkbox"/>	<input type="checkbox"/>	<input type="checkbox"/>	<input type="checkbox"/>	<input type="checkbox"/>	<input type="checkbox"/>	<input type="checkbox"/>	<input type="checkbox"/>
24 36 84	MOD8STAVOPPD243684	2964	3187	3377	<input type="checkbox"/>	<input type="checkbox"/>	<input type="checkbox"/>	<input type="checkbox"/>	<input type="checkbox"/>	<input type="checkbox"/>	<input type="checkbox"/>	<input type="checkbox"/>
24 30 65	MOD8STAVOPWD243065	1949	2172	2361	<input type="checkbox"/>	<input type="checkbox"/>	<input type="checkbox"/>	<input type="checkbox"/>	<input type="checkbox"/>	<input type="checkbox"/>	<input type="checkbox"/>	<input type="checkbox"/>
24 36 65	MOD8STAVOPWD243665	2016	2239	2428	<input type="checkbox"/>	<input type="checkbox"/>	<input type="checkbox"/>	<input type="checkbox"/>	<input type="checkbox"/>	<input type="checkbox"/>	<input type="checkbox"/>	<input type="checkbox"/>
24 30 72	MOD8STAVOPWD243072	2006	2228	2418	<input type="checkbox"/>	<input type="checkbox"/>	<input type="checkbox"/>	<input type="checkbox"/>	<input type="checkbox"/>	<input type="checkbox"/>	<input type="checkbox"/>	<input type="checkbox"/>
24 36 72	MOD8STAVOPWD243672	2070	2293	2483	<input type="checkbox"/>	<input type="checkbox"/>	<input type="checkbox"/>	<input type="checkbox"/>	<input type="checkbox"/>	<input type="checkbox"/>	<input type="checkbox"/>	<input type="checkbox"/>
24 30 84	MOD8STAVOPWD243084	2141	2364	2553	<input type="checkbox"/>	<input type="checkbox"/>	<input type="checkbox"/>	<input type="checkbox"/>	<input type="checkbox"/>	<input type="checkbox"/>	<input type="checkbox"/>	<input type="checkbox"/>
24 36 84	MOD8STAVOPWD243684	2216	2439	2628	<input type="checkbox"/>	<input type="checkbox"/>	<input type="checkbox"/>	<input type="checkbox"/>	<input type="checkbox"/>	<input type="checkbox"/>	<input type="checkbox"/>	<input type="checkbox"/>

RESOURCES

PULLS

EDGES

STORAGE ACCESSORIES

69

FINISHES

76

Shelf finish matches case finish specified.



Black
Silver

12
13



Black
Silver

30
31

Touchlatch
NN

Locks

Randomly keyed locks "L" are standard on all storage units. Storage locks can be specified keyed alike "U" if required. Keyed alike option is field installed.

Edge Profile

Edge Code

WoodPlus & 3mm



Smooth

S



Reeded

R



NeoClassic

E

Detailed



Radius

D



Beveled

B



Transitional

T



Reeded

R



Classic

C

For a closer look at edge styles, visit our website.

STORAGE TOWER - AUDIO/VIDEO

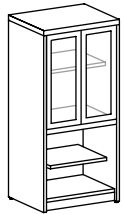

AUDIO VIDEO OPEN / GLASS DOOR

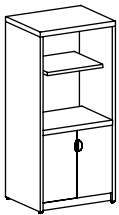

AUDIO VIDEO WOOD DOOR / OPEN

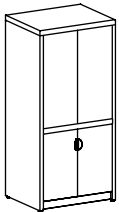

AUDIO VIDEO WOOD DOOR / POCKET DOOR

D / W / H

D / W / H	PRODUCT	EDGE				OPTIONS			FINISHES			
		Wood Plus	3mm	Detailed	Edge Profile	Lock=L Alike=U	Pull	Surface	Edge	Case	Face	
		P	W	D	See Below	See Below	See Below					
		\$	\$	\$								
24 30 65	MOD8STAVOPGD243065	2455	2678	2867	<input type="checkbox"/>	-	-	<input type="checkbox"/>	<input type="checkbox"/>	<input type="checkbox"/>	<input type="checkbox"/>	-
24 36 65	MOD8STAVOPGD243665	2522	2745	2934	<input type="checkbox"/>	-	-	<input type="checkbox"/>	<input type="checkbox"/>	<input type="checkbox"/>	<input type="checkbox"/>	-
24 30 72	MOD8STAVOPGD243072	2511	2734	2924	<input type="checkbox"/>	-	-	<input type="checkbox"/>	<input type="checkbox"/>	<input type="checkbox"/>	<input type="checkbox"/>	-
24 36 72	MOD8STAVOPGD243672	2576	2799	2988	<input type="checkbox"/>	-	-	<input type="checkbox"/>	<input type="checkbox"/>	<input type="checkbox"/>	<input type="checkbox"/>	-
24 30 84	MOD8STAVOPGD243084	2647	2870	3059	<input type="checkbox"/>	-	-	<input type="checkbox"/>	<input type="checkbox"/>	<input type="checkbox"/>	<input type="checkbox"/>	-
24 36 84	MOD8STAVOPGD243684	2722	2945	3134	<input type="checkbox"/>	-	-	<input type="checkbox"/>	<input type="checkbox"/>	<input type="checkbox"/>	<input type="checkbox"/>	-
24 30 65	MOD8STAVWDOP243065	1949	2172	2361	<input type="checkbox"/>	<input type="checkbox"/>	<input type="checkbox"/>	<input type="checkbox"/>	<input type="checkbox"/>	<input type="checkbox"/>	<input type="checkbox"/>	<input type="checkbox"/>
24 36 65	MOD8STAVWDOP243665	2016	2239	2428	<input type="checkbox"/>	<input type="checkbox"/>	<input type="checkbox"/>	<input type="checkbox"/>	<input type="checkbox"/>	<input type="checkbox"/>	<input type="checkbox"/>	<input type="checkbox"/>
24 30 72	MOD8STAVWDOP243072	2006	2228	2418	<input type="checkbox"/>	<input type="checkbox"/>	<input type="checkbox"/>	<input type="checkbox"/>	<input type="checkbox"/>	<input type="checkbox"/>	<input type="checkbox"/>	<input type="checkbox"/>
24 36 72	MOD8STAVWDOP243672	2070	2293	2483	<input type="checkbox"/>	<input type="checkbox"/>	<input type="checkbox"/>	<input type="checkbox"/>	<input type="checkbox"/>	<input type="checkbox"/>	<input type="checkbox"/>	<input type="checkbox"/>
24 30 84	MOD8STAVWDOP243084	2141	2364	2553	<input type="checkbox"/>	<input type="checkbox"/>	<input type="checkbox"/>	<input type="checkbox"/>	<input type="checkbox"/>	<input type="checkbox"/>	<input type="checkbox"/>	<input type="checkbox"/>
24 36 84	MOD8STAVWDOP243684	2216	2439	2628	<input type="checkbox"/>	<input type="checkbox"/>	<input type="checkbox"/>	<input type="checkbox"/>	<input type="checkbox"/>	<input type="checkbox"/>	<input type="checkbox"/>	<input type="checkbox"/>
24 30 65	MOD8STAVWDPD243065	3105	3328	3517	<input type="checkbox"/>	<input type="checkbox"/>	<input type="checkbox"/>	<input type="checkbox"/>	<input type="checkbox"/>	<input type="checkbox"/>	<input type="checkbox"/>	<input type="checkbox"/>
24 36 65	MOD8STAVWDPD243665	3172	3395	3584	<input type="checkbox"/>	<input type="checkbox"/>	<input type="checkbox"/>	<input type="checkbox"/>	<input type="checkbox"/>	<input type="checkbox"/>	<input type="checkbox"/>	<input type="checkbox"/>
24 30 72	MOD8STAVWDPD243072	3162	3385	3574	<input type="checkbox"/>	<input type="checkbox"/>	<input type="checkbox"/>	<input type="checkbox"/>	<input type="checkbox"/>	<input type="checkbox"/>	<input type="checkbox"/>	<input type="checkbox"/>
24 36 72	MOD8STAVWDPD243672	3226	3449	3639	<input type="checkbox"/>	<input type="checkbox"/>	<input type="checkbox"/>	<input type="checkbox"/>	<input type="checkbox"/>	<input type="checkbox"/>	<input type="checkbox"/>	<input type="checkbox"/>
24 30 84	MOD8STAVWDPD243084	3297	3520	3709	<input type="checkbox"/>	<input type="checkbox"/>	<input type="checkbox"/>	<input type="checkbox"/>	<input type="checkbox"/>	<input type="checkbox"/>	<input type="checkbox"/>	<input type="checkbox"/>
24 36 84	MOD8STAVWDPD243684	3372	3595	3784	<input type="checkbox"/>	<input type="checkbox"/>	<input type="checkbox"/>	<input type="checkbox"/>	<input type="checkbox"/>	<input type="checkbox"/>	<input type="checkbox"/>	<input type="checkbox"/>

RESOURCES

STORAGE ACCESSORIES

69

FINISHES

76

Shelf finish matches case finish specified.

Upper doors ship standard as non-locking touch latch, unless otherwise specified.

Glass Doors do not receive pulls or locks.

Locks and Pull columns specify the lower (drawer) portion of the unit only. For matching locks and pulls of their upper (door) portion, add a "P" at the end of the part number.

PULLS

Pull Style	Pull Color	Pull Code
	Black Silver	12 13
	Black Silver	30 31
	Touchlatch	NN

Locks

Randomly keyed locks "L" are standard on all storage units. Storage locks can be specified keyed alike "U" if required. Keyed alike option is field installed.

EDGES

Edge Profile		Edge Code
WoodPlus & 3mm		
	Smooth	S
	Reeded	R
	NeoClassic	E
Detailed		
	Radius	D
	Beveled	B
	Transitional	T
	Reeded	R
	Classic	C

For a closer look at edge styles, visit our website.

STORAGE TOWER - AUDIO/VIDEO

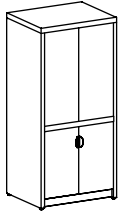
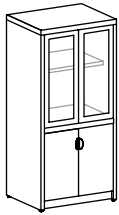
AUDIO VIDEO WOOD DOOR /
WOOD DOORAUDIO VIDEO WOOD DOOR /
GLASS DOOR

D / W / H

D / W / H	PRODUCT	EDGE				OPTIONS			FINISHES			
		Wood Plus	3mm	Detailed	Edge Profile	Lock=L Alike=U	Pull	Surface	Edge	Case	Face	
		P	W	D	See Below	See Below	See Below					
		\$	\$	\$								
24 30 65	MOD8STAVWDWD243065	2357	2580	2769	<input type="checkbox"/>	<input type="checkbox"/>	<input type="checkbox"/>	<input type="checkbox"/>	<input type="checkbox"/>	<input type="checkbox"/>	<input type="checkbox"/>	
24 36 65	MOD8STAVWDWD243665	2424	2647	2836	<input type="checkbox"/>	<input type="checkbox"/>	<input type="checkbox"/>	<input type="checkbox"/>	<input type="checkbox"/>	<input type="checkbox"/>	<input type="checkbox"/>	
24 30 72	MOD8STAVWDWD243072	2413	2636	2826	<input type="checkbox"/>	<input type="checkbox"/>	<input type="checkbox"/>	<input type="checkbox"/>	<input type="checkbox"/>	<input type="checkbox"/>	<input type="checkbox"/>	
24 36 72	MOD8STAVWDWD243672	2478	2701	2890	<input type="checkbox"/>	<input type="checkbox"/>	<input type="checkbox"/>	<input type="checkbox"/>	<input type="checkbox"/>	<input type="checkbox"/>	<input type="checkbox"/>	
24 30 84	MOD8STAVWDWD243084	2548	2771	2961	<input type="checkbox"/>	<input type="checkbox"/>	<input type="checkbox"/>	<input type="checkbox"/>	<input type="checkbox"/>	<input type="checkbox"/>	<input type="checkbox"/>	
24 36 84	MOD8STAVWDWD243684	2624	2846	3036	<input type="checkbox"/>	<input type="checkbox"/>	<input type="checkbox"/>	<input type="checkbox"/>	<input type="checkbox"/>	<input type="checkbox"/>	<input type="checkbox"/>	
24 30 65	MOD8STAVWDGD243065	2863	3086	3275	<input type="checkbox"/>	<input type="checkbox"/>	<input type="checkbox"/>	<input type="checkbox"/>	<input type="checkbox"/>	<input type="checkbox"/>	<input type="checkbox"/>	
24 36 65	MOD8STAVWDGD243665	2930	3152	3342	<input type="checkbox"/>	<input type="checkbox"/>	<input type="checkbox"/>	<input type="checkbox"/>	<input type="checkbox"/>	<input type="checkbox"/>	<input type="checkbox"/>	
24 30 72	MOD8STAVWDGD243072	2919	3142	3332	<input type="checkbox"/>	<input type="checkbox"/>	<input type="checkbox"/>	<input type="checkbox"/>	<input type="checkbox"/>	<input type="checkbox"/>	<input type="checkbox"/>	
24 36 72	MOD8STAVWDGD243672	2984	3207	3396	<input type="checkbox"/>	<input type="checkbox"/>	<input type="checkbox"/>	<input type="checkbox"/>	<input type="checkbox"/>	<input type="checkbox"/>	<input type="checkbox"/>	
24 30 84	MOD8STAVWDGD243084	3054	3277	3467	<input type="checkbox"/>	<input type="checkbox"/>	<input type="checkbox"/>	<input type="checkbox"/>	<input type="checkbox"/>	<input type="checkbox"/>	<input type="checkbox"/>	
24 36 84	MOD8STAVWDGD243684	3129	3352	3542	<input type="checkbox"/>	<input type="checkbox"/>	<input type="checkbox"/>	<input type="checkbox"/>	<input type="checkbox"/>	<input type="checkbox"/>	<input type="checkbox"/>	

RESOURCES

PULLS

EDGES

STORAGE ACCESSORIES

69

FINISHES

76

Shelf finish matches case finish specified.

Upper doors ship standard as non-locking touch latch, unless otherwise specified.

Glass Doors do not receive pulls or locks.

Locks and Pull columns specify the lower (drawer) portion of the unit only. For matching locks and pulls of their upper (door) portion, add a "P" at the end of the part number.

Pull Style

Pull Color

Pull Code

Black
Silver12
13Black
Silver30
31

Touchlatch

NN

Locks

Randomly keyed locks "L" are standard on all storage units. Storage locks can be specified keyed alike "U" if required. Keyed alike option is field installed.

Edge Profile

Edge Code

WoodPlus & 3mm



Smooth

S



Reeded

R



NeoClassic

E

Detailed



Radius

D



Beveled

B



Transitional

T



Reeded

R



Classic

C

For a closer look at edge styles, visit our website.

STORAGE TOWER - BOOKCASE

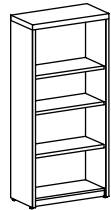

OPEN BOOKCASE

D / W / H	PRODUCT	EDGE				FINISHES		
		Wood Plus	3mm	Detailed	Edge Profile	Surface	Edge	Case
		P	W	D	See Below			
		\$	\$	\$				
12 30 29	MOD8STBKO123029	831	998	1166	<input type="checkbox"/>	<input type="checkbox"/>	<input type="checkbox"/>	<input type="checkbox"/>
12 30 36	MOD8STBKO123036	905	1072	1240	<input type="checkbox"/>	<input type="checkbox"/>	<input type="checkbox"/>	<input type="checkbox"/>
12 30 42	MOD8STBKO123042	952	1120	1287	<input type="checkbox"/>	<input type="checkbox"/>	<input type="checkbox"/>	<input type="checkbox"/>
12 30 48	MOD8STBKO123048	1003	1171	1338	<input type="checkbox"/>	<input type="checkbox"/>	<input type="checkbox"/>	<input type="checkbox"/>
12 30 60	MOD8STBKO123060	1151	1318	1486	<input type="checkbox"/>	<input type="checkbox"/>	<input type="checkbox"/>	<input type="checkbox"/>
12 30 65	MOD8STBKO123065	1222	1390	1557	<input type="checkbox"/>	<input type="checkbox"/>	<input type="checkbox"/>	<input type="checkbox"/>
12 30 72	MOD8STBKO123072	1276	1443	1611	<input type="checkbox"/>	<input type="checkbox"/>	<input type="checkbox"/>	<input type="checkbox"/>
12 30 84	MOD8STBKO123084	1396	1563	1731	<input type="checkbox"/>	<input type="checkbox"/>	<input type="checkbox"/>	<input type="checkbox"/>
12 36 29	MOD8STBKO123629	831	998	1166	<input type="checkbox"/>	<input type="checkbox"/>	<input type="checkbox"/>	<input type="checkbox"/>
12 36 36	MOD8STBKO123636	905	1072	1240	<input type="checkbox"/>	<input type="checkbox"/>	<input type="checkbox"/>	<input type="checkbox"/>
12 36 42	MOD8STBKO123642	952	1120	1287	<input type="checkbox"/>	<input type="checkbox"/>	<input type="checkbox"/>	<input type="checkbox"/>
12 36 48	MOD8STBKO123648	1003	1171	1338	<input type="checkbox"/>	<input type="checkbox"/>	<input type="checkbox"/>	<input type="checkbox"/>
12 36 60	MOD8STBKO123660	1151	1318	1486	<input type="checkbox"/>	<input type="checkbox"/>	<input type="checkbox"/>	<input type="checkbox"/>
12 36 65	MOD8STBKO123665	1222	1390	1557	<input type="checkbox"/>	<input type="checkbox"/>	<input type="checkbox"/>	<input type="checkbox"/>
12 36 72	MOD8STBKO123672	1276	1443	1611	<input type="checkbox"/>	<input type="checkbox"/>	<input type="checkbox"/>	<input type="checkbox"/>
12 36 84	MOD8STBKO123684	1396	1563	1731	<input type="checkbox"/>	<input type="checkbox"/>	<input type="checkbox"/>	<input type="checkbox"/>
15 30 29	MOD8STBKO153029	831	998	1166	<input type="checkbox"/>	<input type="checkbox"/>	<input type="checkbox"/>	<input type="checkbox"/>
15 30 36	MOD8STBKO153036	905	1072	1240	<input type="checkbox"/>	<input type="checkbox"/>	<input type="checkbox"/>	<input type="checkbox"/>
15 30 42	MOD8STBKO153042	952	1120	1287	<input type="checkbox"/>	<input type="checkbox"/>	<input type="checkbox"/>	<input type="checkbox"/>
15 30 48	MOD8STBKO153048	1003	1171	1338	<input type="checkbox"/>	<input type="checkbox"/>	<input type="checkbox"/>	<input type="checkbox"/>
15 30 60	MOD8STBKO153060	1151	1318	1486	<input type="checkbox"/>	<input type="checkbox"/>	<input type="checkbox"/>	<input type="checkbox"/>
15 30 65	MOD8STBKO153065	1261	1428	1596	<input type="checkbox"/>	<input type="checkbox"/>	<input type="checkbox"/>	<input type="checkbox"/>
15 30 72	MOD8STBKO153072	1314	1481	1649	<input type="checkbox"/>	<input type="checkbox"/>	<input type="checkbox"/>	<input type="checkbox"/>
15 30 84	MOD8STBKO153084	1438	1606	1773	<input type="checkbox"/>	<input type="checkbox"/>	<input type="checkbox"/>	<input type="checkbox"/>
15 36 29	MOD8STBKO153629	831	998	1166	<input type="checkbox"/>	<input type="checkbox"/>	<input type="checkbox"/>	<input type="checkbox"/>
15 36 36	MOD8STBKO153636	905	1072	1240	<input type="checkbox"/>	<input type="checkbox"/>	<input type="checkbox"/>	<input type="checkbox"/>
15 36 42	MOD8STBKO153642	952	1120	1287	<input type="checkbox"/>	<input type="checkbox"/>	<input type="checkbox"/>	<input type="checkbox"/>
15 36 48	MOD8STBKO153648	1003	1171	1338	<input type="checkbox"/>	<input type="checkbox"/>	<input type="checkbox"/>	<input type="checkbox"/>
15 36 60	MOD8STBKO153660	1151	1318	1486	<input type="checkbox"/>	<input type="checkbox"/>	<input type="checkbox"/>	<input type="checkbox"/>
15 36 65	MOD8STBKO153665	1261	1428	1596	<input type="checkbox"/>	<input type="checkbox"/>	<input type="checkbox"/>	<input type="checkbox"/>
15 36 72	MOD8STBKO153672	1314	1481	1649	<input type="checkbox"/>	<input type="checkbox"/>	<input type="checkbox"/>	<input type="checkbox"/>
15 36 84	MOD8STBKO153684	1438	1606	1773	<input type="checkbox"/>	<input type="checkbox"/>	<input type="checkbox"/>	<input type="checkbox"/>

RESOURCES

STORAGE ACCESSORIES

69

FINISHES

76

Bookcases include a 3/4-inch thick finished back.

EDGES

Edge Profile

Edge Code

WoodPlus & 3mm



Smooth

S

Reeded

R

NeoClassic

E

Detailed



Radius

D

Beveled

B

Transitional

T

Reeded

R

Classic

C

For a closer look at edge styles, visit our website.

STORAGE TOWER - BOOKCASE

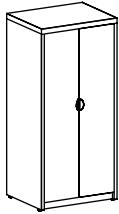

CLOSED BOOKCASE

D / W / H	PRODUCT	Left = L Right = R	EDGE				OPTIONS			FINISHES			
			Wood Plus	3mm	Detailed	Edge Profile	Lock = L Alike = U	Pull	Surface	Edge	Case	Face	
			P	W	D	See Below	See Below	See Below					
			\$	\$	\$								
15 18 65	MOD8STBKC151865	<input type="checkbox"/>	1451	1674	1884	<input type="checkbox"/>	<input type="checkbox"/>	<input type="checkbox"/>	<input type="checkbox"/>	<input type="checkbox"/>	<input type="checkbox"/>	<input type="checkbox"/>	<input type="checkbox"/>
15 30 65	MOD8STBKC153065	<input type="checkbox"/> N	1788	2011	2222	<input type="checkbox"/>	<input type="checkbox"/>	<input type="checkbox"/>	<input type="checkbox"/>	<input type="checkbox"/>	<input type="checkbox"/>	<input type="checkbox"/>	<input type="checkbox"/>
15 36 65	MOD8STBKC153665	<input type="checkbox"/> N	1840	2063	2274	<input type="checkbox"/>	<input type="checkbox"/>	<input type="checkbox"/>	<input type="checkbox"/>	<input type="checkbox"/>	<input type="checkbox"/>	<input type="checkbox"/>	<input type="checkbox"/>
15 18 72	MOD8STBKC151872	<input type="checkbox"/>	1505	1728	1918	<input type="checkbox"/>	<input type="checkbox"/>	<input type="checkbox"/>	<input type="checkbox"/>	<input type="checkbox"/>	<input type="checkbox"/>	<input type="checkbox"/>	<input type="checkbox"/>
15 30 72	MOD8STBKC153072	<input type="checkbox"/> N	1843	2066	2255	<input type="checkbox"/>	<input type="checkbox"/>	<input type="checkbox"/>	<input type="checkbox"/>	<input type="checkbox"/>	<input type="checkbox"/>	<input type="checkbox"/>	<input type="checkbox"/>
15 36 72	MOD8STBKC153672	<input type="checkbox"/> N	1894	2116	2306	<input type="checkbox"/>	<input type="checkbox"/>	<input type="checkbox"/>	<input type="checkbox"/>	<input type="checkbox"/>	<input type="checkbox"/>	<input type="checkbox"/>	<input type="checkbox"/>
15 18 84	MOD8STBKC151884	<input type="checkbox"/>	1628	1851	2061	<input type="checkbox"/>	<input type="checkbox"/>	<input type="checkbox"/>	<input type="checkbox"/>	<input type="checkbox"/>	<input type="checkbox"/>	<input type="checkbox"/>	<input type="checkbox"/>
15 30 84	MOD8STBKC153084	<input type="checkbox"/> N	1965	2188	2398	<input type="checkbox"/>	<input type="checkbox"/>	<input type="checkbox"/>	<input type="checkbox"/>	<input type="checkbox"/>	<input type="checkbox"/>	<input type="checkbox"/>	<input type="checkbox"/>
15 36 84	MOD8STBKC153684	<input type="checkbox"/> N	2025	2248	2458	<input type="checkbox"/>	<input type="checkbox"/>	<input type="checkbox"/>	<input type="checkbox"/>	<input type="checkbox"/>	<input type="checkbox"/>	<input type="checkbox"/>	<input type="checkbox"/>
24 18 65	MOD8STBKC241865	<input type="checkbox"/>	1597	1820	2030	<input type="checkbox"/>	<input type="checkbox"/>	<input type="checkbox"/>	<input type="checkbox"/>	<input type="checkbox"/>	<input type="checkbox"/>	<input type="checkbox"/>	<input type="checkbox"/>
24 30 65	MOD8STBKC243065	<input type="checkbox"/> N	1933	2156	2366	<input type="checkbox"/>	<input type="checkbox"/>	<input type="checkbox"/>	<input type="checkbox"/>	<input type="checkbox"/>	<input type="checkbox"/>	<input type="checkbox"/>	<input type="checkbox"/>
24 36 65	MOD8STBKC243665	<input type="checkbox"/> N	1999	2222	2432	<input type="checkbox"/>	<input type="checkbox"/>	<input type="checkbox"/>	<input type="checkbox"/>	<input type="checkbox"/>	<input type="checkbox"/>	<input type="checkbox"/>	<input type="checkbox"/>
24 18 72	MOD8STBKC241872	<input type="checkbox"/>	1650	1873	2062	<input type="checkbox"/>	<input type="checkbox"/>	<input type="checkbox"/>	<input type="checkbox"/>	<input type="checkbox"/>	<input type="checkbox"/>	<input type="checkbox"/>	<input type="checkbox"/>
24 30 72	MOD8STBKC243072	<input type="checkbox"/> N	1987	2210	2399	<input type="checkbox"/>	<input type="checkbox"/>	<input type="checkbox"/>	<input type="checkbox"/>	<input type="checkbox"/>	<input type="checkbox"/>	<input type="checkbox"/>	<input type="checkbox"/>
24 36 72	MOD8STBKC243672	<input type="checkbox"/> N	2053	2276	2465	<input type="checkbox"/>	<input type="checkbox"/>	<input type="checkbox"/>	<input type="checkbox"/>	<input type="checkbox"/>	<input type="checkbox"/>	<input type="checkbox"/>	<input type="checkbox"/>
24 18 84	MOD8STBKC241884	<input type="checkbox"/>	1788	2011	2222	<input type="checkbox"/>	<input type="checkbox"/>	<input type="checkbox"/>	<input type="checkbox"/>	<input type="checkbox"/>	<input type="checkbox"/>	<input type="checkbox"/>	<input type="checkbox"/>
24 30 84	MOD8STBKC243084	<input type="checkbox"/> N	2126	2349	2559	<input type="checkbox"/>	<input type="checkbox"/>	<input type="checkbox"/>	<input type="checkbox"/>	<input type="checkbox"/>	<input type="checkbox"/>	<input type="checkbox"/>	<input type="checkbox"/>
24 36 84	MOD8STBKC243684	<input type="checkbox"/> N	2198	2421	2632	<input type="checkbox"/>	<input type="checkbox"/>	<input type="checkbox"/>	<input type="checkbox"/>	<input type="checkbox"/>	<input type="checkbox"/>	<input type="checkbox"/>	<input type="checkbox"/>

RESOURCES

PULLS

EDGES

STORAGE ACCESSORIES

69

FINISHES

76

Bookcases include a finished back.

18 inch wide units include one door, left/right hand is based on the door hinges.

Pull Style

Pull Color

Pull Code



Black
Silver

12
13



Black
Silver

30
31

Touchlatch

NN

Locks

Randomly keyed locks "L" are standard on all storage units. Storage locks can be specified keyed alike "U" if required. Keyed alike option is field installed.

Edge Profile

Edge Code

WoodPlus & 3mm



Smooth

S



Reeded

R



NeoClassic

E

Detailed



Radius

D



Beveled

B



Transitional

T



Reeded

R



Classic

C

For a closer look at edge styles, visit our website.

LIBRARY SHELVING

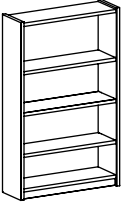
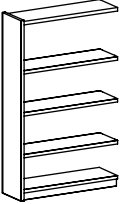
	D / W / H	PRODUCT	EDGE		Edge Profile	FINISHES
			Wood Plus	3mm		
			P	W		
			\$	\$		
	12 38 42	MOD8LSST42	851	1018	S	□□
	12 38 60	MOD8LSST60	945	1113	S	□□
	12 38 72	MOD8LSST72	1079	1247	S	□□
	12 38 84	MOD8LSST84	1214	1382	S	□□
	12 36 42	MOD8LSAD42	736	904	S	□□
	12 36 60	MOD8LSAD60	838	1005	S	□□
	12 36 72	MOD8LSAD72	995	1162	S	□□
	12 36 84	MOD8LSAD84	1073	1241	S	□□

LIBRARY SHELVING, STARTER

LIBRARY SHELVING, ADDER

STORAGE ACCESSORIES

69

FINISHES

76

Library Shelving is NOT freestanding. Components must be wall mounted.

Extra Adjustable Shelf and Periodical Display Shelf available for Library Shelving, see page 70 to order.

NOTES

For Customer Service Inquiries, please contact:

800.426.1202

360.394.1322 *fax*

www.magnadesign.com

ACCESSORIES

ACCESSORIES

Hutch Accessories	66
Wall Mounted Tackboard	68
Storage Accessories	69
Desk Accessories	71

HUTCH ACCESSORIES

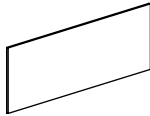

HUTCH TACKBOARD

A / B

A / B		PRODUCT	Price	Paper Shelf	Fabric
			\$	Yes = P No = N	
35	36	MOD8FPI3536	257	N	<input type="checkbox"/> <input type="checkbox"/>
35	42	MOD8FPI3542	257	N	<input type="checkbox"/> <input type="checkbox"/>
35	48	MOD8FPI3548	257	N	<input type="checkbox"/> <input type="checkbox"/>
35	54	MOD8FPI3554	257	N	<input type="checkbox"/> <input type="checkbox"/>
35	60	MOD8FPI3560	257	N	<input type="checkbox"/> <input type="checkbox"/>
35	66	MOD8FPI3566	294	N	<input type="checkbox"/> <input type="checkbox"/>
35	72	MOD8FPI3572	294	N	<input type="checkbox"/> <input type="checkbox"/>
35	78	MOD8FPI3578	331	N	<input type="checkbox"/> <input type="checkbox"/>
35	84	MOD8FPI3584	331	N	<input type="checkbox"/> <input type="checkbox"/>
35	90	MOD8FPI3590	331	N	<input type="checkbox"/> <input type="checkbox"/>
35	96	MOD8FPI3596	331	N	<input type="checkbox"/> <input type="checkbox"/>
35	102	MOD8FPI35102	331	N	<input type="checkbox"/> <input type="checkbox"/>
35	108	MOD8FPI35108	331	N	<input type="checkbox"/> <input type="checkbox"/>
35	114	MOD8FPI35114	331	N	<input type="checkbox"/> <input type="checkbox"/>
35	120	MOD8FPI35120	331	N	<input type="checkbox"/> <input type="checkbox"/>
42	36	MOD8FPI4236	257	<input type="checkbox"/>	<input type="checkbox"/> <input type="checkbox"/>
42	42	MOD8FPI4242	257	<input type="checkbox"/>	<input type="checkbox"/> <input type="checkbox"/>
42	48	MOD8FPI4248	257	<input type="checkbox"/>	<input type="checkbox"/> <input type="checkbox"/>
42	54	MOD8FPI4254	257	<input type="checkbox"/>	<input type="checkbox"/> <input type="checkbox"/>
42	60	MOD8FPI4260	257	<input type="checkbox"/>	<input type="checkbox"/> <input type="checkbox"/>
42	66	MOD8FPI4266	294	<input type="checkbox"/>	<input type="checkbox"/> <input type="checkbox"/>
42	72	MOD8FPI4272	294	<input type="checkbox"/>	<input type="checkbox"/> <input type="checkbox"/>
42	78	MOD8FPI4278	331	<input type="checkbox"/>	<input type="checkbox"/> <input type="checkbox"/>
42	84	MOD8FPI4284	331	<input type="checkbox"/>	<input type="checkbox"/> <input type="checkbox"/>
42	90	MOD8FPI4290	331	<input type="checkbox"/>	<input type="checkbox"/> <input type="checkbox"/>
42	96	MOD8FPI4296	331	<input type="checkbox"/>	<input type="checkbox"/> <input type="checkbox"/>
54	36	MOD8FPI5436	257	<input type="checkbox"/>	<input type="checkbox"/> <input type="checkbox"/>
54	42	MOD8FPI5442	257	<input type="checkbox"/>	<input type="checkbox"/> <input type="checkbox"/>
54	48	MOD8FPI5448	257	<input type="checkbox"/>	<input type="checkbox"/> <input type="checkbox"/>
54	54	MOD8FPI5454	257	<input type="checkbox"/>	<input type="checkbox"/> <input type="checkbox"/>
54	60	MOD8FPI5460	257	<input type="checkbox"/>	<input type="checkbox"/> <input type="checkbox"/>
54	66	MOD8FPI5466	294	<input type="checkbox"/>	<input type="checkbox"/> <input type="checkbox"/>
54	72	MOD8FPI5472	294	<input type="checkbox"/>	<input type="checkbox"/> <input type="checkbox"/>
54	78	MOD8FPI5478	331	<input type="checkbox"/>	<input type="checkbox"/> <input type="checkbox"/>
54	84	MOD8FPI5484	331	<input type="checkbox"/>	<input type="checkbox"/> <input type="checkbox"/>
54	90	MOD8FPI5490	331	<input type="checkbox"/>	<input type="checkbox"/> <input type="checkbox"/>
54	96	MOD8FPI5496	331	<input type="checkbox"/>	<input type="checkbox"/> <input type="checkbox"/>

PRODUCT NOTES

Listed tackboard dimensions are to match Hutch dimensions ordered.

Paper Shelf option "P" reduces the height by 7 inches to accommodate a Hutch with a paper shelf.

HUTCH ACCESSORIES

PRODUCT

FINISHES

A / B	
35	36
35	42
35	48
35	54
35	60
35	66
35	72
35	78
35	84
35	90
35	96
35	102
35	108
35	114
35	120

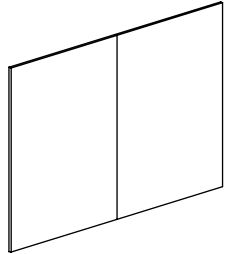
**HUTCH EXTERIOR TACKBOARD**

35 High, 60 Wide Shown

		Price	Fabric
		\$	
	MOD8FPE3536	257	<input type="checkbox"/>
	MOD8FPE3542	257	<input type="checkbox"/>
	MOD8FPE3548	257	<input type="checkbox"/>
	MOD8FPE3554	257	<input type="checkbox"/>
	MOD8FPE3560	257	<input type="checkbox"/>
	MOD8FPE3566	294	<input type="checkbox"/>
	MOD8FPE3572	294	<input type="checkbox"/>
	MOD8FPE3578	331	<input type="checkbox"/>
	MOD8FPE3584	331	<input type="checkbox"/>
	MOD8FPE3590	331	<input type="checkbox"/>
	MOD8FPE3596	331	<input type="checkbox"/>
	MOD8FPE35102	331	<input type="checkbox"/>
	MOD8FPE35108	331	<input type="checkbox"/>
	MOD8FPE35114	331	<input type="checkbox"/>
	MOD8FPE35120	331	<input type="checkbox"/>
	MOD8FPE4236	257	<input type="checkbox"/>
	MOD8FPE4242	257	<input type="checkbox"/>
	MOD8FPE4248	257	<input type="checkbox"/>
	MOD8FPE4254	257	<input type="checkbox"/>
	MOD8FPE4260	257	<input type="checkbox"/>
	MOD8FPE4266	294	<input type="checkbox"/>
	MOD8FPE4272	294	<input type="checkbox"/>
	MOD8FPE4278	331	<input type="checkbox"/>
	MOD8FPE4284	331	<input type="checkbox"/>
	MOD8FPE4290	331	<input type="checkbox"/>
	MOD8FPE4296	331	<input type="checkbox"/>
	MOD8FPE5436	257	<input type="checkbox"/>
	MOD8FPE5442	257	<input type="checkbox"/>
	MOD8FPE5448	257	<input type="checkbox"/>
	MOD8FPE5454	257	<input type="checkbox"/>
	MOD8FPE5460	257	<input type="checkbox"/>
	MOD8FPE5466	294	<input type="checkbox"/>
	MOD8FPE5472	294	<input type="checkbox"/>
	MOD8FPE5478	331	<input type="checkbox"/>
	MOD8FPE5484	331	<input type="checkbox"/>
	MOD8FPE5490	331	<input type="checkbox"/>
	MOD8FPE5496	331	<input type="checkbox"/>

PRODUCT NOTES

Listed tackboard dimensions are to match Hutch dimensions ordered.

36 to 48 inch wide Tackboard ships as one tiles.

54 to 96 inch wide Tackboard ships as two tiles.

102 to 120 inch wide Tackboard ships as three tiles.

ACCESSORIES

PRODUCT

FINISHES

A / B

Price

Fabric

\$

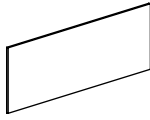

WALL MOUNTED TACKBOARD

18	30	FPW1830	257	<input type="checkbox"/>	<input type="checkbox"/>
18	36	FPW1836	257	<input type="checkbox"/>	<input type="checkbox"/>
18	42	FPW1842	257	<input type="checkbox"/>	<input type="checkbox"/>
18	48	FPW1848	257	<input type="checkbox"/>	<input type="checkbox"/>
18	54	FPW1854	257	<input type="checkbox"/>	<input type="checkbox"/>
18	60	FPW1860	257	<input type="checkbox"/>	<input type="checkbox"/>
18	66	FPW1866	294	<input type="checkbox"/>	<input type="checkbox"/>
18	72	FPW1872	294	<input type="checkbox"/>	<input type="checkbox"/>
18	78	FPW1878	331	<input type="checkbox"/>	<input type="checkbox"/>
18	84	FPW1884	331	<input type="checkbox"/>	<input type="checkbox"/>
18	90	FPW1890	331	<input type="checkbox"/>	<input type="checkbox"/>
18	96	FPW1896	331	<input type="checkbox"/>	<input type="checkbox"/>
25	30	FPW2530	257	<input type="checkbox"/>	<input type="checkbox"/>
25	36	FPW2536	257	<input type="checkbox"/>	<input type="checkbox"/>
25	42	FPW2542	257	<input type="checkbox"/>	<input type="checkbox"/>
25	48	FPW2548	257	<input type="checkbox"/>	<input type="checkbox"/>
25	54	FPW2554	257	<input type="checkbox"/>	<input type="checkbox"/>
25	60	FPW2560	257	<input type="checkbox"/>	<input type="checkbox"/>
25	66	FPW2566	294	<input type="checkbox"/>	<input type="checkbox"/>
25	72	FPW2572	294	<input type="checkbox"/>	<input type="checkbox"/>
25	78	FPW2578	331	<input type="checkbox"/>	<input type="checkbox"/>
25	84	FPW2584	331	<input type="checkbox"/>	<input type="checkbox"/>
25	90	FPW2590	331	<input type="checkbox"/>	<input type="checkbox"/>
25	96	FPW2596	331	<input type="checkbox"/>	<input type="checkbox"/>

PRODUCT NOTES

STORAGE ACCESSORIES

PRODUCT

FINISHES

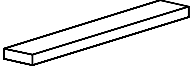
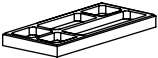
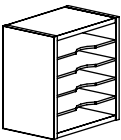
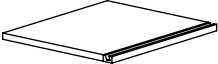
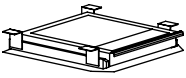
	D / W / H	PRODUCT	Price	Laminate
 TASKLIGHT	7 21 2	WL24	92	-
	7 27 2	WL30	100	-
	7 33 2	WL36	115	-
	7 39 2	WL42	125	-
	7 45 2	WL48	133	-
 PENCIL TRAY INSERT	6 11 1	PTI	10	-
 DESKTOP ORGANIZER	10 15 16	DTO5	317	<input type="checkbox"/> <input type="checkbox"/>
	10 15 19	DTO6	317	<input type="checkbox"/> <input type="checkbox"/>
 AUDIO VIDEO TV TRAY		MOD8TVT15	684	<input type="checkbox"/> <input type="checkbox"/>
		MOD8TVT20	684	<input type="checkbox"/> <input type="checkbox"/>
 CENTER DRAWER		MGACDM21	51	-

PRODUCT NOTES

Task Light cord is 8 feet long extending from the center back of light. Task Light has built-in light diffuser.

Pencil tray includes brackets for side-to-side hanging in box drawers.

DTO5 fits below the valance of a hutch at 35 inches high, or below the valance of a hutch at 42 inches high with a paper shelf.

DTO6 fits below the valance of a hutch at 42 inches high without a paper shelf.

Audio Video TV Tray finish is black.

STORAGE ACCESSORIES

PRODUCT	EDGE			FINISHES
	Wood Plus	3mm	Edge Profile	
	P	W		Laminate
	\$	\$		
MOD8FB1529	221	-	S	<input type="checkbox"/> <input type="checkbox"/>
MOD8LSPD36	129	155	S	<input type="checkbox"/> <input type="checkbox"/>
MOD8LSSH36	66	58	S	<input type="checkbox"/> <input type="checkbox"/>

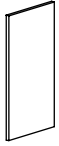

PEDESTAL FINISHED BACK

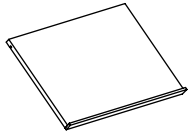

PERIODICAL DISPLAY SHELF

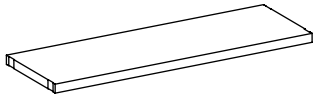

EXTRA ADJUSTABLE SHELF

PRODUCT NOTES

Pedestal Finished Backs are required when using Inset or Flush Modesty Panels.

DESK ACCESSORIES

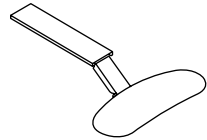

**ADD-ON KEYBOARD,
RETRACTABLE**

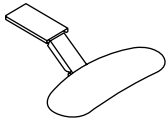

ADD-ON KEYBOARD



KEYBOARD CORNER



SPLICE PLATE

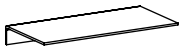

ANGLE BRACKET

PRODUCT	Price	EDGE			FINISHES	
		Wood Plus P	3mm W	Edge Profile <i>See Below</i>	Laminate	Edge
DAKB	\$ 244	-	-	-	-	-
DAVKB	402	-	-	-	-	-
MOD8KC1212	-	283	497	☐	☐☐	☐☐
MGASPO	21	-	-	-	-	-
MGAAB	28	-	-	-	-	-

PRODUCT NOTES

Add-on Keyboards are retractable along a 24 inch track. Location of the keyboard track may be impacted by obstacles beneath the worksurface and worksurface depth. Please contact customer service for details.

Splice Plate is used to connect two units of the same height. IE: A desk extension at right angle to a shell desk.

Angle Brackets are used to connect a Shell desk with an extension when used in a straight line.

EDGES

Edge Profile		Edge Code
WoodPlus & 3mm		
	Smooth	S
	Reeded	R
	NeoClassic	E

For a closer look at edge styles, visit our website.

DESK ACCESSORIES

PRODUCT



GROMMET
Set of Five

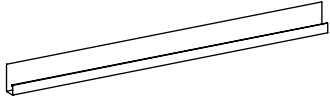

J-TRACK WIREMANAGER, MOUNTED
(attaches to Modesty Panel)

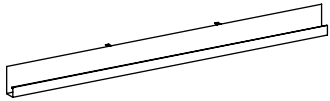

J-TRACK WIREMANAGER
(attaches to Worksurface)



WIRE MANAGER
(field adjustable)

	Price
DAGR	\$ 25
MGAMJTMP72	77
MGAMJTWS72	77
MGAWM72	43

PRODUCT NOTES

J-Track Wiremanager, Mounted attaches to a Modesty Panel.

J-Track Wiremanager mounts to a worksurface and includes brackets.

Wiremanager can be cut to length in the field and mounted underneath the worksurface.

MATERIALS & SPECIFICATIONS

Mod Eight

The Mod Eight group is designed to offer the ultimate in modular flexibility. It integrates both desk shell based and worktop/ storage based systems. The extremely wide range of shell and worktop sizes, configurations, modular storage, privacy screen and electrical options combine to offer a high degree of space plan application.

Mod Eight is offered in a wide variety of finish and detail options. Magna WoodPlus/ColorPlus laminate finishes will satisfy and compliment any interior specification.

Worksurfaces

Worksurfaces are 1-3/4" thick and are composed of horizontal grades of plastic laminate and backing material bonded to a 1-7/8" industrial grade particleboard. Magna particleboard is recovered from Douglas Fir. The longer strands of the Douglas Fir provide superior deflection characteristics.

Edges

Woodplus:

These are synthetic edges made of 3mm thermo-fused PVC. Edges consist of a "through-grain", which shows the unique grain pattern on the trimmed edges and routed profiles. Choice of three edge profiles.

3mm:

These are solid 3mm hardwood edges. Edges are stained and finished to match worksurface and storage finish selected. Choice of three edge profiles.

Detailed:

These are solid 3/8" hardwood edges. Edges are stained and finished to match worksurface and storage finish selected. Choice of five edge profiles.

End panels

All end panels are 1-1/8" thick, three ply balanced construction. Bottom edges of end panels are additionally banded with a 3mm or WoodPlus edge band to insure a structural base for leveling glides.

Front, Modesty and back panels

All desk front, modesty and back panels are 3/4" thick, three ply balanced construction.

Storage Pedestals

Cases:

3/4" TFL case material.

Edging:

.5mm PVC edge, color and grain matched to case. All Surfaces and edges are finished.

Drawers:

Metal drawer bodies feature full extension 100lb (200lb for lateral files) ball bearing slides.

Leveling Glides:

Nylon based steel leveling glides with steel mounting brackets

Locks:

Locks are keyed randomly at the factory or can be keyed alike in the field.

Storage Towers, Overheads, Hutches

Cases:

3/4" TFL case material with 1 1/8" TFL side panels. Top is 1 3/4" to match worksurfaces.

Edging:

Same edge types and profiles as worksurface options. See "Edges"

Drawers:

Drawer bodies feature full extension 100lb (200lb for lateral files) ball bearing slides.

Leveling Glides:

Nylon based steel leveling glides with steel mounting brackets

Locks:

Locks are keyed randomly at the factory or can be keyed alike in the field.

Important Ordering Notes

A FLOOR PLAN of your Mod Eight layout is required to process your order. All hardware needed for assembly will be provided based on your floor plan.

Specifications subject to change without notice.

TERMS AND CONDITIONS

Terms of Sale

This Price List and these Terms of Sale supersede all previous price lists and terms. These prices and terms are subject to change without notice.

Prices

List prices include freight costs as specified below. No other charges are included in Magna's list prices unless otherwise specified in writing.

Terms of Payment

Terms of payment will be established based on the credit rating and credit information provided by and for specific customers. Orders are invoiced at time of shipment. Standard payment terms are 50/50; 50% due at time of order and 50% due at time of shipment. Approved credit levels may be extended to net thirty (30).

Past due accounts will be charged the lesser of 1.5% per month or the highest rate permitted by law plus all collection costs, including reasonable attorney's fees and expenses.

Taxes

The Customer shall pay all sales, use, excise and other taxes applicable to the sale. Resale and/or exemption certificates must be forwarded to Magna at the time of order.

Order Acceptance

All orders must be submitted in writing. Magna does not accept an order until the order is verified complete by a Magna Project Manager, which will include price information and anticipated arrival date. The Order Confirmation is the final expression of the contract between the Customer and Watson.

Order Changes and Cancellations

Purchase orders may not be changed or cancelled, in whole or in part, without prior written consent of Magna. Changes may effect delivery dates. Expenses incurred because of changes will be charged to Customer. In the event of cancellations, Customer will be liable for reasonable cancellation charges established by Magna. Orders for customized products, custom finishes and Customer's Own Material (COM) items, hereinafter defined, may not be cancelled.

Returns

The return of Products without a written authorization by Magna shall not be accepted. If Magna agrees to repurchase the product pursuant to a valid authorization, the Customer must return the Product freight prepaid to Magna. The returned product shall be subject to a 25% of list restocking charge. All returned Products must be unused and in original condition. Magna will not accept returns on orders that include COM materials.

Landed Freight Program

Order Minimums have been determined to help us accurately compensate for our freight expenses on low-volume orders. Minimum order and freight charge rates for all territories * have been specified below by zone.

* *Overseas and non-contiguous US shipments made to a prearranged departure port in any zone, will adhere to the defined order minimum and freight charges in that zone; carton packing charges may also apply to overseas shipments.*

ZONE 1

Alaska and Hawaii

· Customer responsible for all freight charges applied following product departure from Seattle, WA shipping dock.

ZONE 2

Continental United States and Canada

· For all orders less than \$15,000 list, a freight charge of 10% net invoice total will be applied.

Shipping

Magna employs an environmentally friendly shipping program that reduces costs and helps ensure furniture is delivered in the same condition as it left the factory. This careful handling may occasionally lengthen shipping times on LTL shipments.

Packaging

Worksurfaces and storage components are sent blanket wrapped. This process eliminates waste and reduces installation time associated with package removal and disposal.

The Customer may specify cartoning. To specify cartoning for all items, add 5% of total list price.

Air-ride

Magna utilizes carriers whose trailers are equipped with air-ride suspension to minimize vibration and avoid damage in transit.

Alternative Shipping

At Magna's discretion and if it is determined in the best interest of customers, alternative shipping methods may be used. Special requests including special shipping methods, delivery outside normal hours (8 a.m. to 5 p.m. Monday through Friday), inside delivery, notification, etc. shall be subject to an additional charge to the customer.

Claims

Risk of loss passes to Customer upon Magna's delivery of the product to the carrier. Product shortages and damage must be noted on delivery receipts at the time of receipt by the Customer or Customer's agent. If the carrier damaged the Product while in transit, the Customer has sole obligation of seeking any recourse against the appropriate carrier. Claims against Magna for shortages and errors must be made within seven (7) days of the date of delivery.

Title

Title to the Product shall remain with Magna until the Product is fully paid for.

Storage

Magna may transfer Product to storage at the Customer's risk and expense if the Customer is unable to take delivery of product as scheduled. Upon such transfer to storage, the Customer assumes risk of loss. Magna will invoice the Customer on a monthly basis for storage fees and the Customer will make payments in accordance with Magna's standard payment terms.

Loss, Damage or Delay

Magna shall not be liable for any loss, damage or delay resulting from forces beyond its reasonable control including fire, flood, strike or other labor difficulty, act of God, inability to obtain necessary labor, materials, or manufacturing facilities from usual sources, failure of suppliers to meet their contractual obligations or due to any cause beyond its reasonable control.

In the event of any such delay, delivery will be postponed by such length of time as may be reasonably necessary to compensate for the delay.

Customer's Own Material (COM)

Customers may request fabrics, surface materials, and powdercoats that are not standard to Magna's finish offering according to the guidelines below.

Magna Customer Service will apprise customers of any possible impact on lead times resulting from the use of off-card materials and finishes.

Magna shall not be responsible for the appearance or performance of any COM material and customer shall hold Magna harmless for any damages or losses arising out of, or related to, the use of the COM on the Product.

PRODUCT REPAIR OR REPLACEMENT IS THE CUSTOMER'S EXCLUSIVE REMEDY FOR ANY AND ALL PRODUCT DEFECTS.

COM orders cannot be cancelled and Magna will not accept product returns.

TERMS AND CONDITIONS (CONTINUED)

Fabric

- All COM requests for special fabric must be tested and approved by Magna.
- A minimum sample of 3 yards must be submitted to Magna for testing.
- Magna will notify customer of test results within 5 business days and provide written approval and a COM request form.
- Upon approval, customer must provide production quantities of the approved fabric at least five days before production begins.
- No price adjustments will be made for customer supplied fabric.

Laminates

- Magna must approve all COM requests for laminates not listed on finish card.
- Non-specialty laminates from WilsonArt that are not on our finish card will be available subject to a \$500 list upcharge for recycling excess materials.
- For requests concerning all other vendors and all specialty laminates, please contact Customer Service, which will determine manufacturability, schedule, and pricing.
- Evaluation of requests will take no longer than three business days.
- Magna will contact laminate vendors directly to determine availability and lead times.
- Upon approval and order acknowledgement, Magna will purchase COM laminates and arrange delivery to facilitate the production schedule.

Powder

- Customer must provide powder sample for testing.
- Upon approval, customer must provide production quantity powder three days in advance of scheduled beginning of production.
- No price adjustments will be made for customer supplied powder.

Warranty

Magna warrants that its products are free from defects in design, material, and workmanship under normal use and with proper care and maintenance. This warranty will remain in effect for the following period of time, commencing with the date of purchase from Magna but only so long as the original customer continues to own the product.

This warranty does not apply to:

- Damage caused during shipment.
- Any product installed or used other than in accordance with Magna guidelines.
- Any product that has been repaired, altered or modified by any person other than Magna.
- Any attachment added to a product.
- Any fabric or upholstery material.
- Any part or material provided by the customer.
- Any damage caused by misuse, abuse, or negligence on the part of customer or any third party.

Warranty Period

This warranty will remain in effect for the following period of time, commencing with the date of purchase from Magna but only so long as the original purchaser continues to own the product.

- All products and components not previously listed - Lifetime
- Drawer Slides - Lifetime
- Electrical components and functional mechanisms, like keyboard trays - Five Years
- Wood Finishes - Three Years

During the term of this warranty, Magna will repair or replace with the same or comparable product or part without charge any product or part that malfunctions or fails to conform to this warranty.

THIS REMEDY OF REPAIR OR REPLACEMENT IS CUSTOMER'S SOLE AND EXCLUSIVE REMEDY WITH REGARD TO ANY PRODUCT DEFECT.

THERE ARE NO OTHER WARRANTIES, EITHER EXPRESSED OR IMPLIED, INCLUDING ANY WARRANTY OF MERCHANTABILITY OR OF FITNESS FOR A PARTICULAR PURPOSE. UNDER NO CIRCUMSTANCES WILL MAGNA BE LIABLE FOR ANY CONSEQUENTIAL OR INCIDENTAL DAMAGES ARISING FROM ANY PRODUCT DEFECT.

JUNE 2010

FINISHES

Visit www.magnadesign.com/finishes for finish color representations or to order sample chips.

LAMINATES

(Surface & Storage Finish)

AI	Anigre
09	Blossom Cherry
CU	Chestnut
KP	Chocolate Pear
C7	Cognac
NQ	Espresso
FE	Fine Sycamore*
FM	Fusion Maple
G6	Golden Cherry
G7	Grove Cherry
KM	Kensington Maple
KN	Kona*
DI	Medium Cherry
JP	Mocha Cherry
F9	Sipping Seattle Java
TW	Tuscan Walnut*

*Available July 1, 2010

FABRICS*DRIFT PATTERN*

ØR	Alabaster
1H	Chamois
ØD	Dusty Miller
ØI	Graphite
3K	Mocha
9P	Pebble
4T	Slate
7U	Sprout
3J	Storm

SPRITE PATTERN

4U	Butter
2V	Harvest
7K	Khaki
4K	Kiwi
2I	Linen
4D	Powder
4B	Sherbet
7Y	Sky
2W	Snow

PVC EDGE

(Woodplus Edge Material)

AI	Anigre
BK	Black
09	Blossom Cherry
CU	Chestnut
C7	Cognac
FM	Fusion Maple
G7	Grove Cherry
KM	Kensington Maple
DI	Medium Cherry
F9	Sipping Seattle Java

WOOD EDGE

(3mm & Detailed Edge Material)

AI	Anigre
BK	Black
09	Blossom Cherry
CU	Chestnut
KP	Chocolate Pear
C7	Cognac
FM	Fusion Maple
G6	Golden Cherry
G7	Grove Cherry
KM	Kensington Maple
DI	Medium Cherry
JP	Mocha Cherry
F9	Sipping Seattle Java

POWDERCOAT

BK	Black
WA	White Aluminum

THIS PAGE INTENTIONALLY LEFT BLANK.

About Magna Design

Magna Design, a Watson brand, is manufactured to exacting specifications in our state-of-the-art facility located in Poulsbo, Washington. Watson is a leader in Practical Environmentalism applying low-impact manufacturing practices, waste reduction efforts, recycling programs, and a heavy reliance on recycled materials to the development of our products. For more than 40 years, Watson has proven its unwavering commitment to quality manufacturing, customer service, and responsibility - toward employees, neighbors, and the environment.

